



TDA7372A

4 x 6W POWER AMPLIFIER FOR CAR RADIO

- HIGH POWER CAPABILITY:
4x6W min/4Ω @14.4V, 1KHz, 10%
4x10W typ/2Ω @14.4V, 1KHz, 10%
- MINIMUM EXTERNAL COMPONENT COUNT
 - INTERNALLY FIXED GAIN (20dB)
 - NO BOOTSTRAP CAPACITORS
 - NO EXTERNAL COMPENSATION
- ST-BY FUNCTION (CMOS COMPATIBLE)
- MUTE FUNCTION (CMOS COMPATIBLE)
- NO AUDIBLE POP DURING MUTE/ST-BY OPERATIONS
- LOW SUPPLY SELF MUTING
- PROGRAMMABLE TURN ON DELAY

PROTECTIONS:

- AC OUTPUT SHORT CIRCUIT TO GND
- DC OUTPUT SHORT CIRCUIT TO GND AND TO V_S AT POWER ON
- SOFT THERMAL LIMITER
- OVERRATING CHIP TEMPERATURE
- LOAD DUMP VOLTAGE

BLOCK DIAGRAM

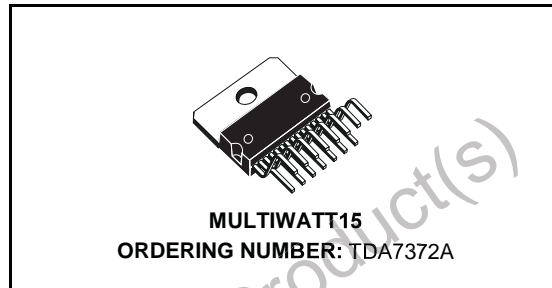
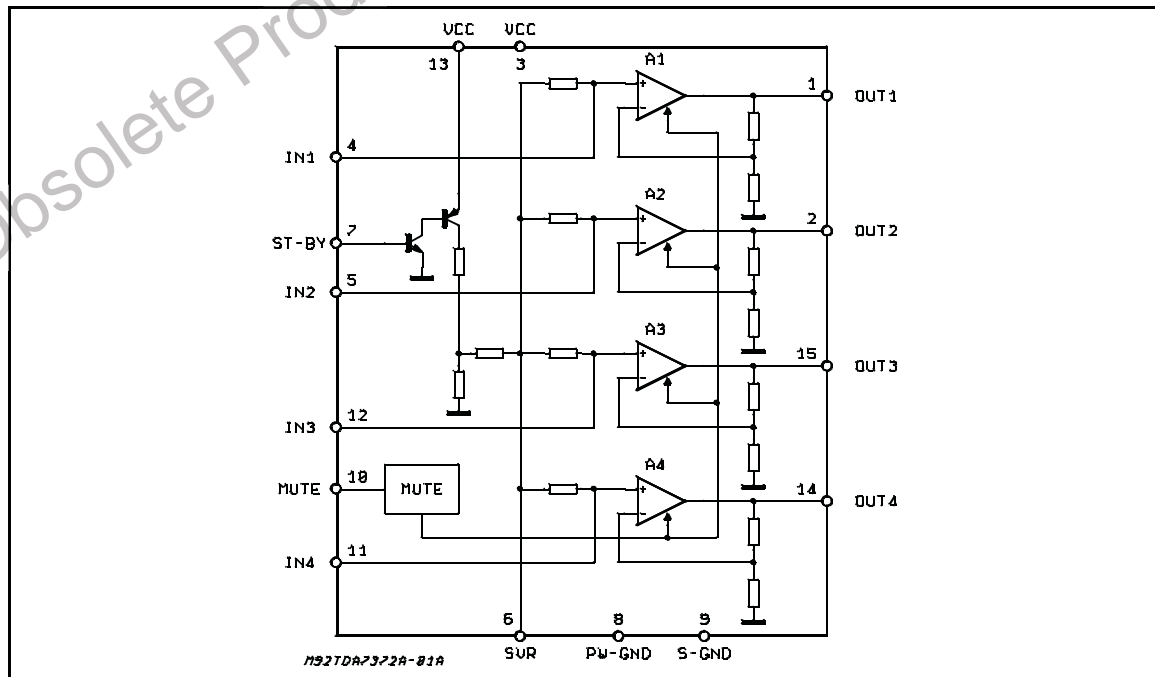

- FORTUITOUS OPEN GND
- REVERSED BATTERY
- ESD PROTECTION

DESCRIPTION

The TDA7372A is a new technology class AB quad channels Audio Power Amplifier in Multiwatt15 package designed for car radio applications.

Thanks to the fully complementary PNP/NPN output configuration the TDA7372A delivers a rail to rail voltage swing with no need of bootstrap capacitors.

TDA7372A

PIN CONNECTION (Top view)

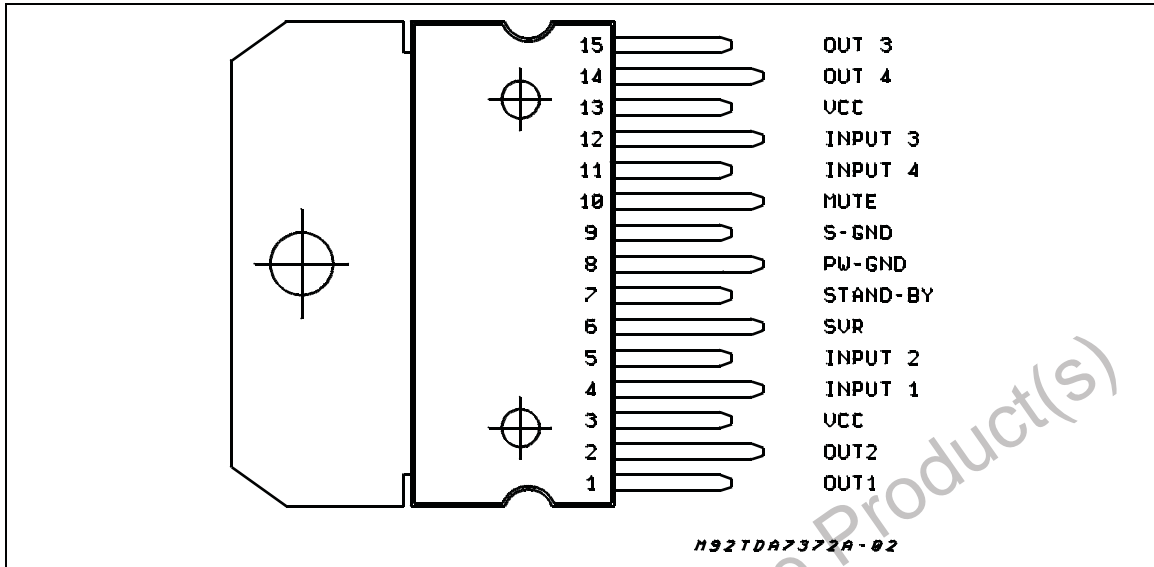

ABSOLUTE MAXIMUM RATINGS

Symbol	Parameter	Value	Unit
V_S	DC Supply Voltage	28	V
V_{OP}	Operating Supply Voltage	18	V
V_{PEAK}	Peak Supply Voltage ($t = 50\text{ms}$)	50	V
I_o	Output Peak Current (not rep. $t = 100\mu\text{s}$)	4	A
I_o	Output Peak Current (rep. $f > 10\text{Hz}$)	3	A
P_{tot}	Power Dissipation ($T_{case} = 85^\circ\text{C}$)	32	W
T_{stg}, T_j	Storage and Junction Temperature	-40 to 150	$^\circ\text{C}$

THERMAL DATA

Symbol	Description	Value	Unit
$R_{th\ j-case}$	Thermal Resistance Junction-case	Max 2	$^\circ\text{C/W}$

ELECTRICAL CHARACTERISTICS (Refer to the test circuit; $V_S = 14.4V$; $R_L = 4\Omega$, $T_{amb} = 25^\circ C$, $f = 1kHz$, unless otherwise specified)

Symbol	Parameter	Test Condition	Min.	Typ.	Max.	Unit
V_S	Supply Range		8		18	V
I_d	Total Quiescent Drain Current				150	mA
P_O	Output Power	$R_L = 4\Omega$; THD = 10% each channel	6	6.5		W
		$R_L = 2\Omega$; THD = 10% each channel		10		W
d	Distortion	$R_L = 4\Omega$; $P_O = 0.1$ to 3W		0.04	0.3	%
CT	Cross Talk	$f = 1kHz$; $R_g = 0$ $f = 10kHz$; $R_g = 0$	54	60 55		dB dB
R_{IN}	Input Impedance		35			K Ω
G_V	Voltage Gain		19	20	21	dB
G_V	Voltage Gain Match.				1	dB
BW	Bandwidth	@ -3dB	100			KHz
E_{NO}	Output Noise Voltage (*)	$R_g = 0$			120	μV
SVR	Supply Voltage Rejection	$R_g = 0$; $f = 100Hz$	48			dB
ASB	Stand-by Attenuation		80			dB
I_{SB}	ST-BY Current Consumption	$V_{pin7} = 1.5V$			100	μA
I_{PIN7}	ST-BY Pin Current	Play mode; $V_{pin7} = 5V$			30	μA
		Output Under Short (Max driving current under fault)			5	mA
$V_{SB IN}$	ST-BY IN Threshold Voltage				1.5	V
$V_{SB OUT}$	ST-BY OUT Threshold Voltage		3.5			V
A_M	MUTE Attenuation			80		dB
$V_{M IN}$	MUTE IN Threshold Voltage				1.5	V
$V_{M OUT}$	MUTE OUT Threshold Voltage		3.5			V

(*) 22Hz to 22KHz

TEST AND APPLICATION CIRCUIT

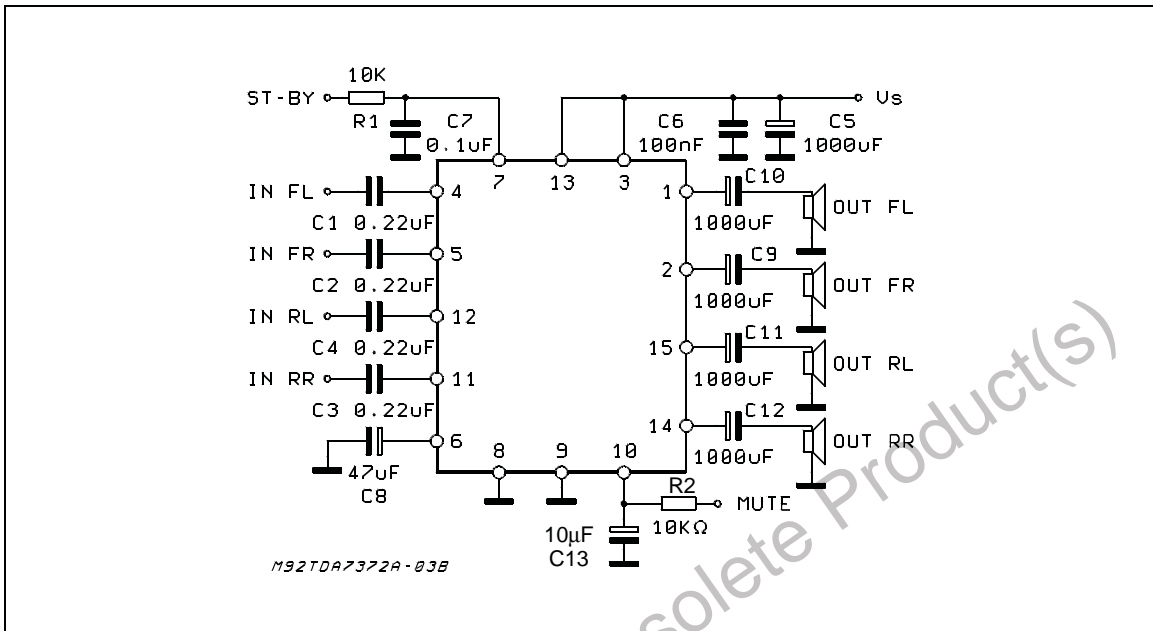

Figure 1: P.C. Board and components layout of the Test and Application Circuit (1:1 scale)

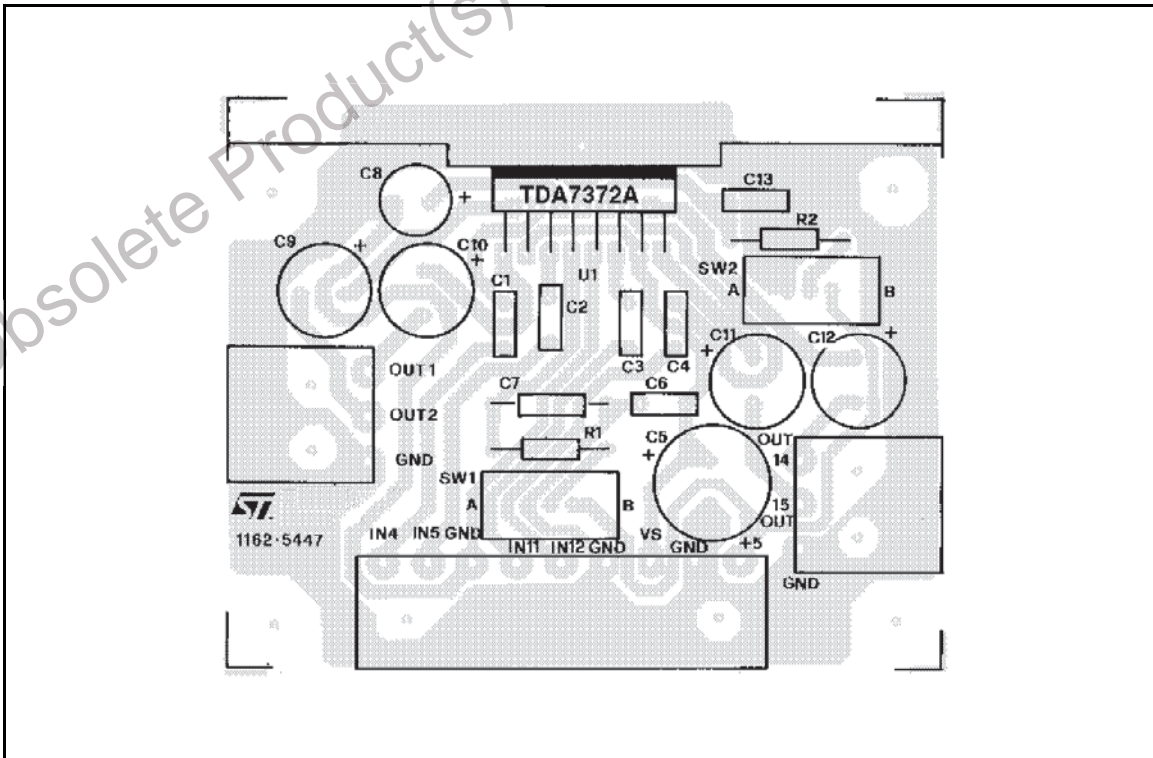

Figure 2: Quiescent Drain Current vs. Supply Voltage

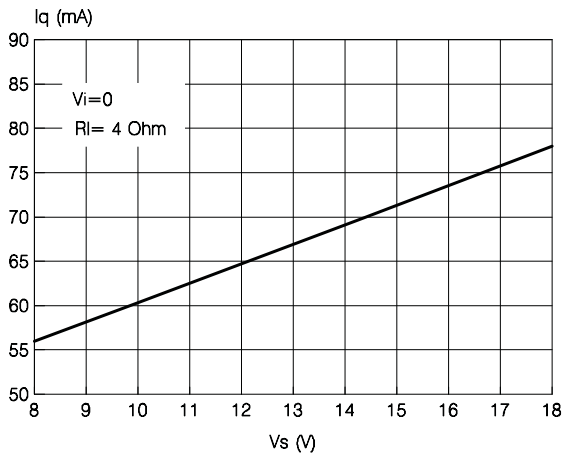

Figure 4: Output Power vs Supply Voltage

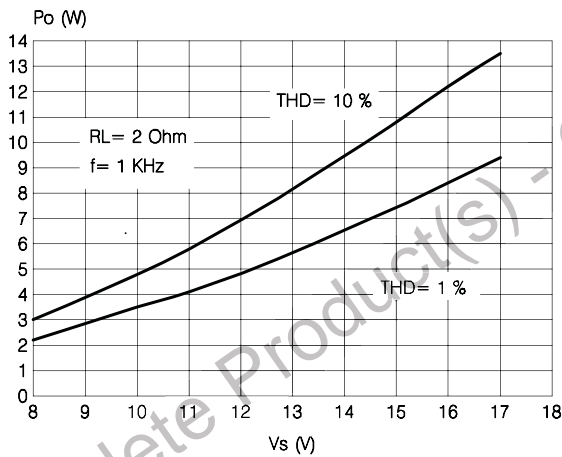

Figure 6: Distortion vs. Output Power

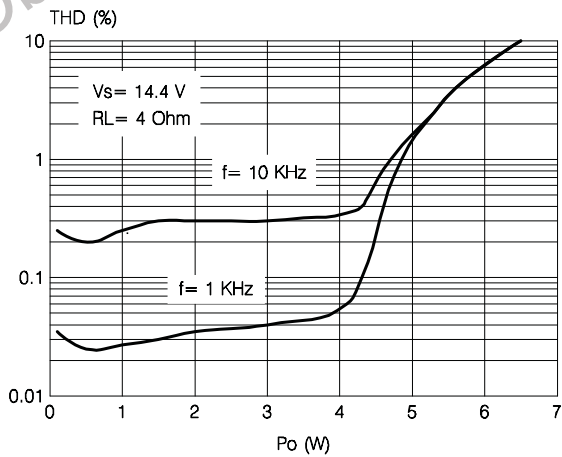

Figure 3: Output Power vs. Supply Voltage

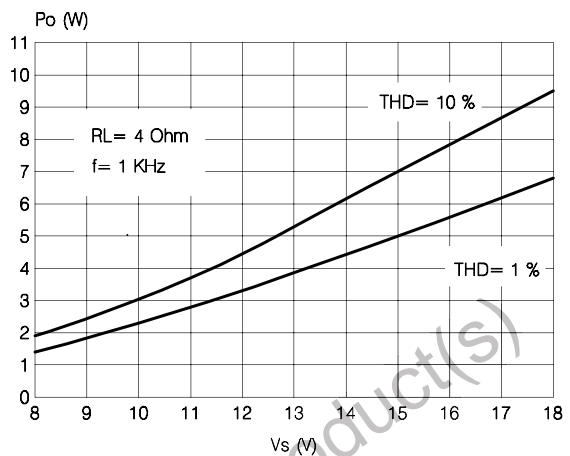

Figure 5: Output power vs. Frequency vs. Cout Value

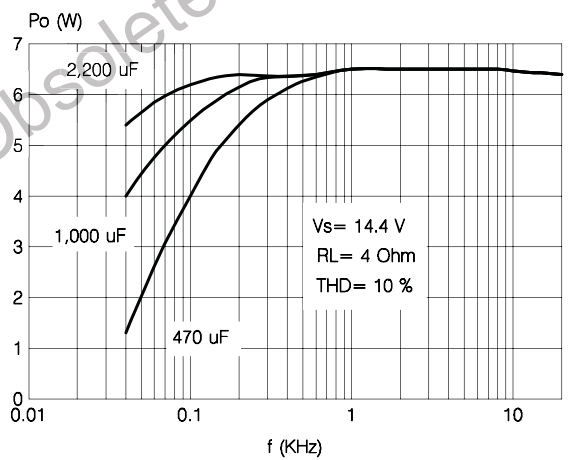

Figure 7: Distortion vs. Output Power

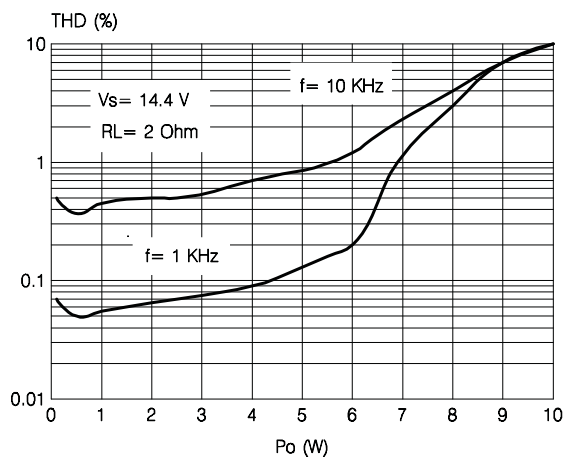

Figure 8: Distortion vs. Frequency

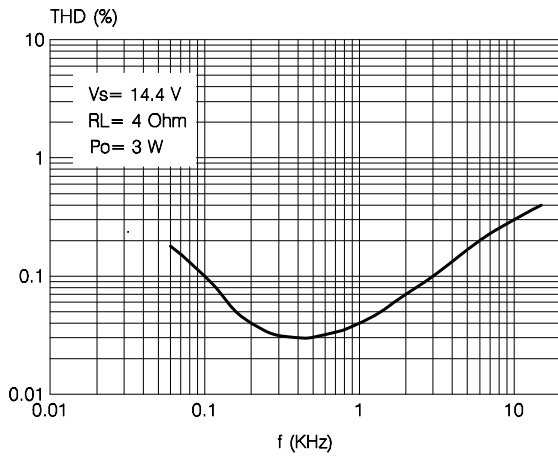

Figure 10: Cross-Talk vs. Frequency

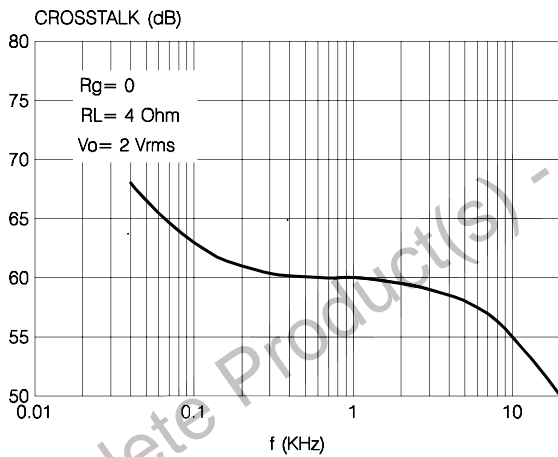

Figure 12: Total Power Dissipation and Efficiency vs. Output Power

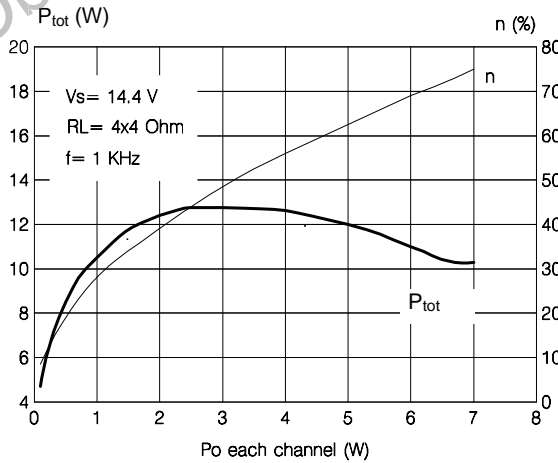

Figure 9: Distortion vs. Frequency

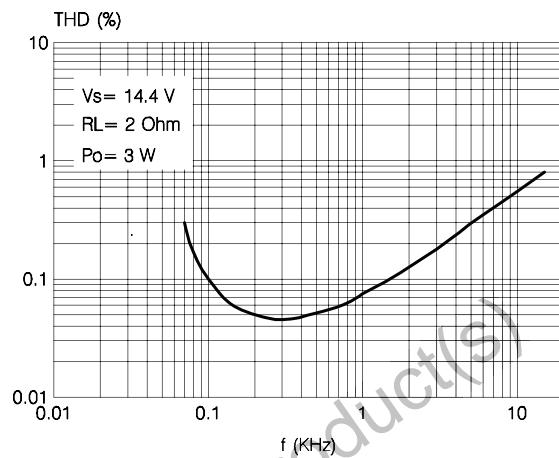

Figure 11: Supply Voltage Rejection vs. Frequency

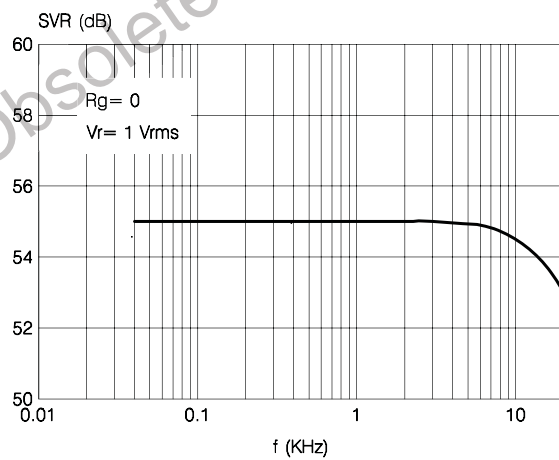

Figure 13: Total Power Dissipation and Efficiency vs. Output Power

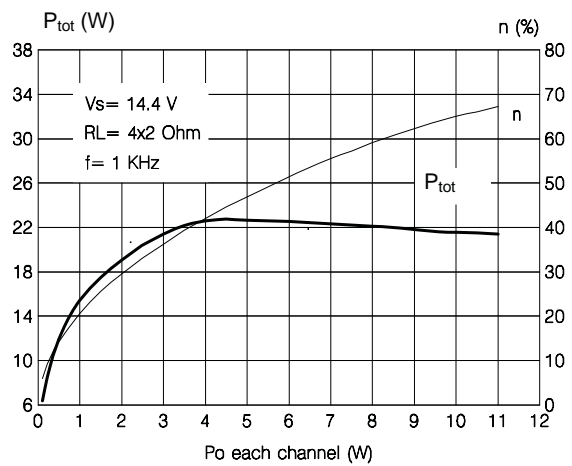
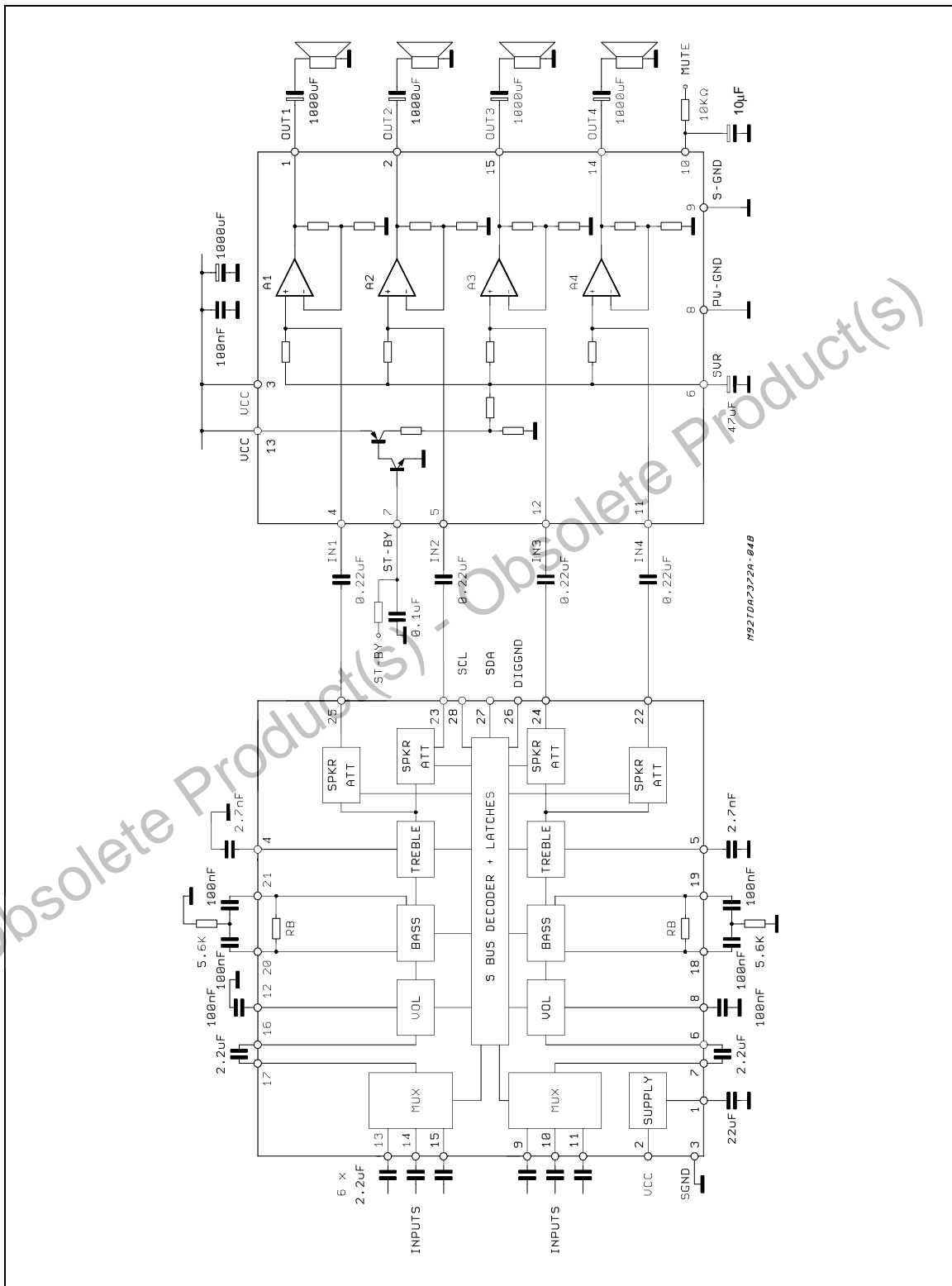

Figure 14: TDA7313 + 7372 Application Circuit



TDA7372A

FUNCTIONAL DESCRIPTION

Function	Description
GENERAL	The TDA7372A is a quad channel single package audio power amplifier intended to reduce the mismatch in the electrical characteristics among the four different channels and to consistently drop the external component count. It contains four non inverting stages capable to operate down to 20dB gain so minimizing the output noise and optimizing SVR and distortion.
OUTPUT STAGE	The output stage is a single ended type suitable to drive 4Ω loads. It consists of a class AB fully complementary PNP/NPN stages short circuit protected. A rail to rail output swing is achieved without need of bootstrap capacitors. Moreover, the external compensation is not necessary.
ST-BY	The device features a St-BY function which shuts down the internal bias generators when the ST-BY input is low. In ST-BY mode the amplifier sinks a small current (in the range of few μAs). When the St-BY pin is high the IC becomes fully operational.
MUTE	A mute function is also provided. This reduces the gain of the input stage to a level effectively eliminating any audio input influence on the output stage when the mute line is low. When the mute line is high the normal input path is restored. The device goes automatically into mute state when the supply voltage goes below the minimum allowable value. This prevents pop noises whenever the battery voltage drops below a fixed threshold. When the supply voltage rises to its nominal value the device recovers the play condition with a delay fixed by the C _{SVR} capacitor.
THERMAL PROTECTION	The Thermal protection principle involves two different steps a) Soft thermal limitation b) Shutdown As long as the junction temperature remains below a preset threshold, the I.C. will deliver the full power. Once the threshold has been reached, the device automatically goes into mute status. The play to mute transition is internally controlled so producing a soft muting without unpleasant effect. Supposing the junction temperature does not reduce to safe levels, a complete shutdown will occur.
BUILT-IN SHORT CIRCUIT PROTECTION	A built-in protection circuit assures reliable and safe operation in presence of: - AC short circuit to GND - DC short circuit to GND and to V _S during power-on phase The DC short protector acts in a way to avoid that the device is being turned on (by ST-BY) when a DC short is present from OUT to GND or OUT to V _S . Due to this reason it is necessary to introduce a proper delay on the st-by pin (especially when it is driven by V _S .) Moreover, as the involved circuitry is normally disabled when a current higher than 5mA is fed into the st-by pin, it is important, in order not to disable it, to have the external current source driving the pin itself limited to 5mA. (figure 1 shows the relevant waveforms).

Figure 15: Fault (DC short) waveforms

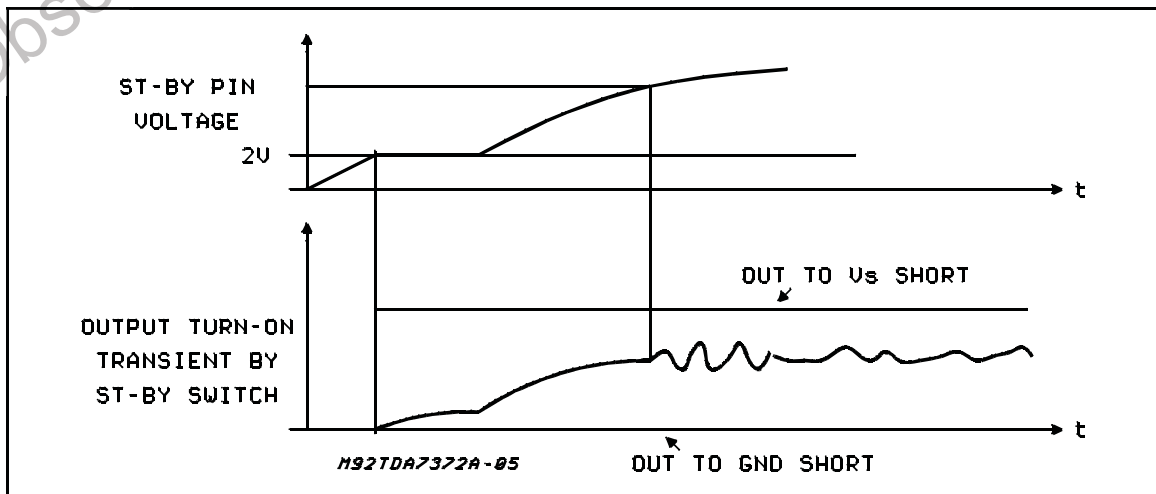

DIM.	mm			inch		
	MIN.	TYP.	MAX.	MIN.	TYP.	MAX.
A			5			0.197
B			2.65			0.104
C			1.6			0.063
D		1			0.039	
E	0.49		0.55	0.019		0.022
F	0.66		0.75	0.026		0.030
G	1.02	1.27	1.52	0.040	0.050	0.060
G1	17.53	17.78	18.03	0.690	0.700	0.710
H1	19.6			0.772		
H2			20.2			0.795
L	21.9	22.2	22.5	0.862	0.874	0.886
L1	21.7	22.1	22.5	0.854	0.870	0.886
L2	17.65		18.1	0.695		0.713
L3	17.25	17.5	17.75	0.679	0.689	0.699
L4	10.3	10.7	10.9	0.406	0.421	0.429
L7	2.65		2.9	0.104		0.114
M	4.25	4.55	4.85	0.167	0.179	0.191
M1	4.63	5.08	5.53	0.182	0.200	0.218
S	1.9		2.6	0.075		0.102
S1	1.9		2.6	0.075		0.102
Dia1	3.65		3.85	0.144		0.152

OUTLINE AND MECHANICAL DATA

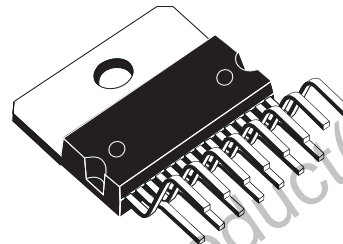

Multiwatt15 V

