

PE43713 Evaluation Kit (EVK) User's Manual

UltraCMOS® RF Digital Step Attenuator, 9 kHz–6 GHz

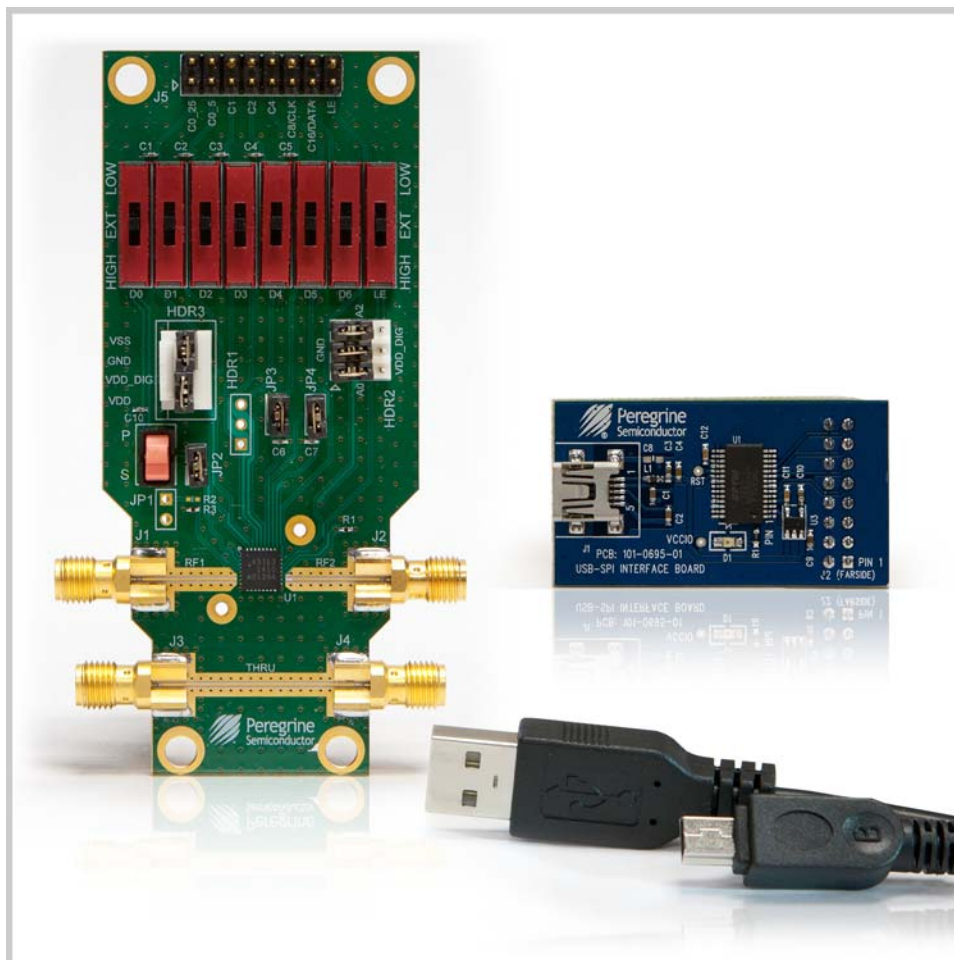

Copyright and Trademarks

©2015, Peregrine Semiconductor Corporation. All rights reserved. The Peregrine name, logo, UTSi and UltraCMOS are registered trademarks and HaRP, MultiSwitch and DuNE are trademarks of Peregrine Semiconductor Corp.

Disclaimers

The information in this document is believed to be reliable. However, Peregrine assumes no liability for the use of this information. Use shall be entirely at the user's own risk. No patent rights or licenses to any circuits described in this document are implied or granted to any third party. Peregrine's products are not designed or intended for use in devices or systems intended for surgical implant, or in other applications intended to support or sustain life, or in any application in which the failure of the Peregrine product could create a situation in which personal injury or death might occur. Peregrine assumes no liability for damages, including consequential or incidental damages, arising out of the use of its products in such applications.

Patent Statement

Peregrine products are protected under one or more of the following U.S. patents: patents.psemi.com

Sales Contact

For additional information, contact Sales at sales@psemi.com.

Corporate Headquarters

9369 Carroll Park Drive, San Diego, CA, 92121
858-731-9400

Table of Contents

Introduction - - - - -	1
Introduction - - - - -	1
Application Support	1
Evaluation Kit Contents and Requirements	1
Kit Contents	1
Software Requirements	2
Hardware Requirements	2
Evaluation Board Assembly - - - - -	3
Evaluation Board Assembly Overview - - - - -	3
Quick Start Guide - - - - -	5
Quick Start Guide Overview - - - - -	5
Software Installation - - - - -	5
USB Driver	5
EVK Software	5
Hardware Configuration - - - - -	8
USB Interface Board Overview	8
Connection of the USB Interface Board to the Evaluation Board	8
Evaluation Board Overview	9
Hardware Operation	11
Using the Graphical User Interface - - - - -	12
Technical Resources - - - - -	17
Technical Resources - - - - -	17

Introduction



Introduction

The PE43713 is a 50Ω HaRP™ technology-enhanced, 7-bit RF digital step attenuator (DSA) designed for use in 3G/4G wireless infrastructure and other high performance RF applications. An integrated digital control interface supports both serial and parallel programming of the attenuation. Covering a 31.75 dB attenuation range in 0.25 dB steps, it maintains high linearity and low power consumption from 9 kHz through 6 GHz. PE43713 features glitch-less attenuation state transitions and is offered in a 32-lead 5 × 5 mm QFN package. In addition, no external blocking capacitors are required if 0 VDC is present on the RF ports.

The PE43713 evaluation kit (EVK) includes the application software and hardware required to control and evaluate the functionality of the DSA using a PC running the Windows operating system to control the USB interface board. The EVK can also be operated manually. Refer to “**Hardware Operation**” in **Chapter 3**, page 11 for instructions on manually programming the EVK in Direct Parallel mode.

Application Support

For any technical inquiries regarding the evaluation kit or software, please visit applications support at www.psemi.com (fastest response) or call (858) 731-9400.

Evaluation Kit Contents and Requirements

Kit Contents

The PE43713 Evaluation Kit (EVK) includes all of the specific software and hardware required to evaluate the DSA. Included in the EVK are:

Table 1 • PE43713 Evaluation Kit Contents

Quantity	Description
1	PE43713 DSA Evaluation Board Assembly (PRT-45305)
1	Peregrine USB Interface Board Assembly (PRT-50446)
1	USB 2.0 Type A to Type B Mini Cable

Software Requirements

The application software will need to be installed on a computer with the following minimum requirements:

- PC compatible with Windows™ XP, Vista, 7 or 8
- Mouse
- USB port
- HTML browser with internet access
- Administrative privileges

Hardware Requirements

In order to evaluate the step attenuation performance of the evaluation board, the following equipment is required:

- DC power supplies and DC cables
- Vector network analyzer

Caution: The PE43713 DSA EVK contains components that might be damaged by exposure to voltages in excess of the specified voltage, including voltages produced by electrostatic discharges. Handle the board in accordance with procedures for handling static-sensitive components. Avoid applying excessive voltages to the power supply terminals or signal inputs or outputs.

Evaluation Board Assembly



Evaluation Board Assembly Overview

The evaluation board is assembled with a PE43713 DSA, SP2T mechanical switch (P/S), SP3T mechanical switches (D0–D6,LE), several headers and SMA connectors. The P/S switch is used for Parallel or Serial mode selection. The D0–D6,LE switches are used for setting the control bits in Direct Parallel programming mode.

Figure 1 • PE43713 Evaluation Board Assembly

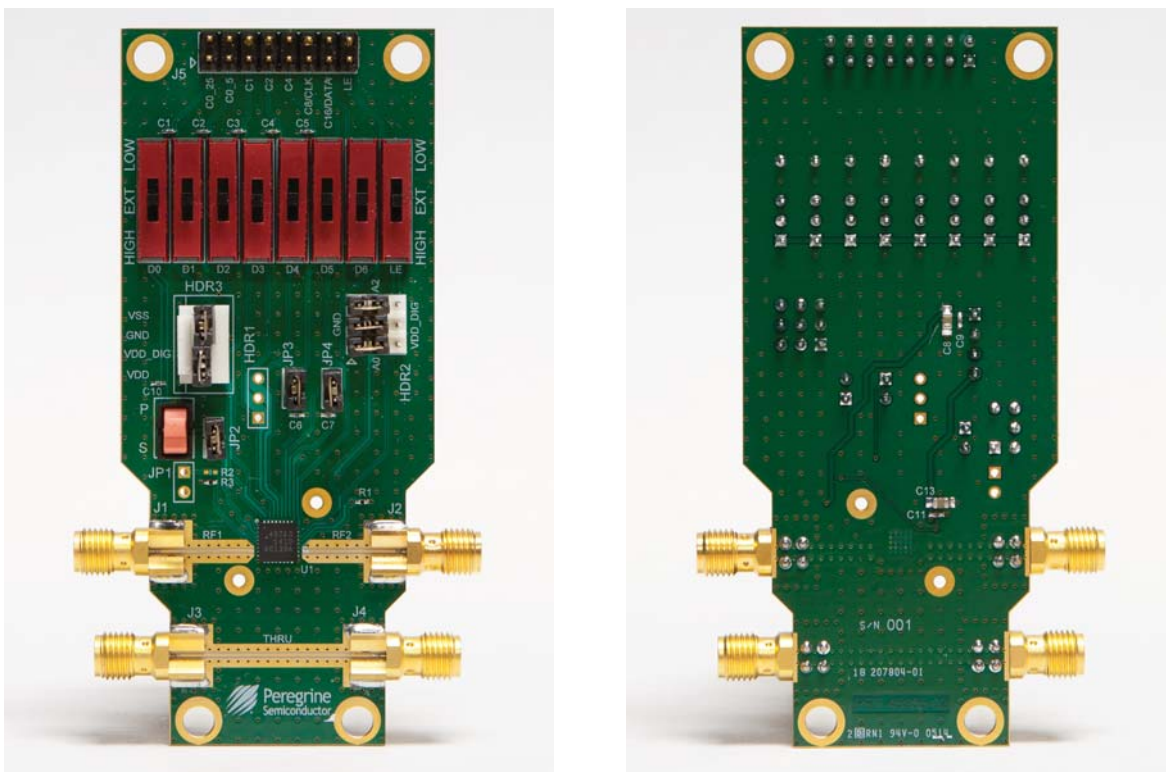

Quick Start Guide



Quick Start Guide Overview

The digital attenuator evaluation board (EVB) was designed to ease customer evaluation of the PE43713 digital step attenuator. This chapter will guide the user through the software installation, hardware configuration and using the graphical user interface (GUI).

Software Installation

USB Driver

The latest USB interface board drivers are available via Microsoft Windows update. Internet connectivity is required to download the drivers. Connect the USB interface board to the PC and select the Windows Update option to obtain and install the drivers.

If the USB board drivers are not installed, it will not be possible to run the program correctly. A USB interface board (Figure 2) is included in the evaluation kit.

Figure 2 • DSA USB Driver Installation

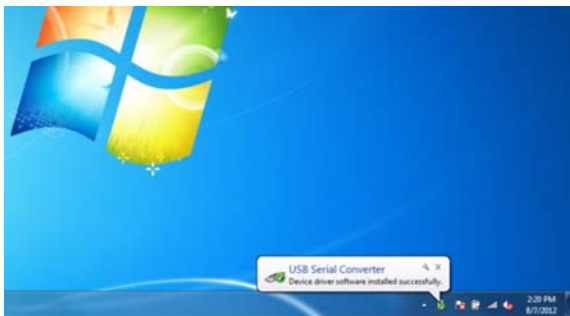

EVK Software

In order to evaluate the PE43713 performance, the application software has to be installed on your computer. The USB interface and DSA application software is compatible with computers running

Windows™ XP, Vista, 7 or 8. This software is available directly from Peregrine's website at www.psemi.com.

To install the DSA evaluation software, unzip the archive and execute the "setup.exe."

Figure 3 • DSA Evaluation Software Installer



After the setup.exe file has been executed, a welcome screen will appear. It is strongly recommended that all programs be closed prior to running the install program. Click the "Next>" button to proceed.

Figure 4 • DSA Evaluation Software Setup



Take a moment to read the license agreement, then click "I Agree" and "Next>."

Figure 5 • License Agreement

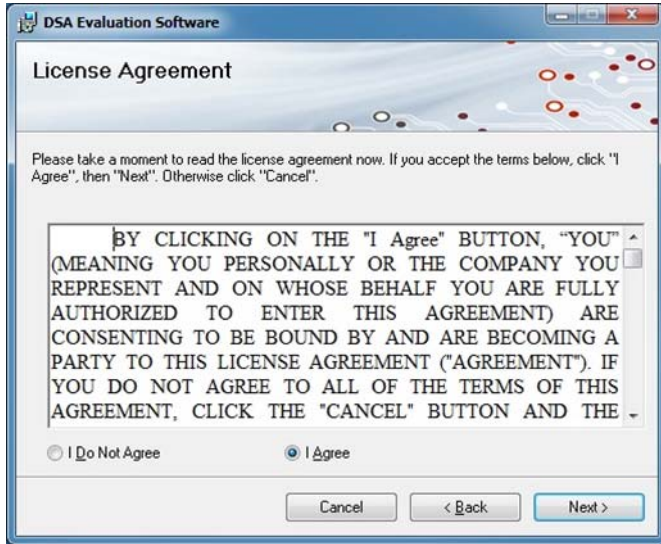

For most users the default install location for the program files is sufficient. If a different location is desired, the install program can be directed to place the program files in an alternate location. The software is installed for "Everyone" by default. Once the desired location is selected click "Next>."

Figure 6 • Select Installation Folder



In the window of Confirm Installation, click "Next>" to proceed with the software installation.

Figure 7 • Confirm Installation

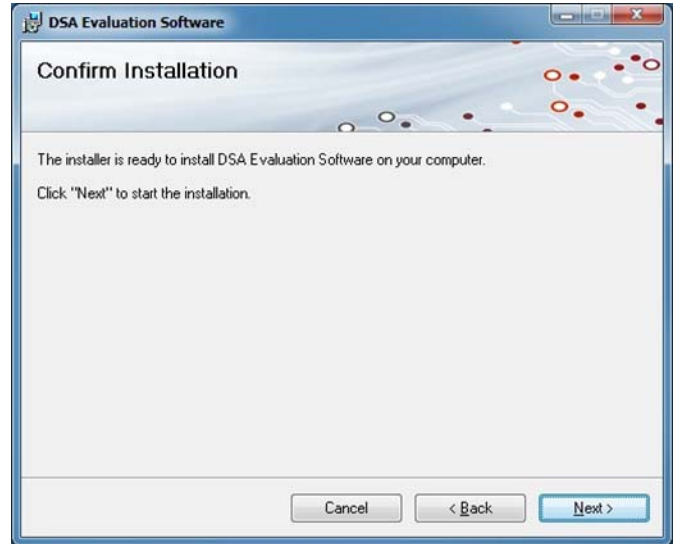

As the software files are installed, a progress indicator will be displayed. On slower computers, installation of the software may proceed for a few moments.

Figure 8 • Progress Indicator



Once the evaluation software is installed, click "Close" to exit.

Figure 9 • Installation Complete

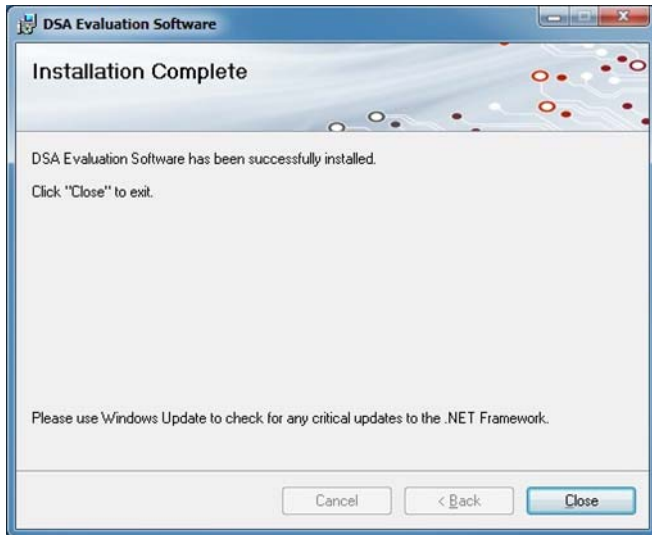

A new Start Menu item under Peregrine Semiconductor will appear in the start menu of your computer. Select "DSA Evaluation Software" to launch the GUI.

Figure 10 • DSA Evaluation Software Launch

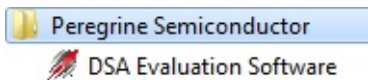

Hardware Configuration

USB Interface Board Overview

A USB interface board (**Figure 11**) is included in the evaluation kit. This board allows the user to send serial peripheral interface (SPI) commands to the device under test by using a PC running the Windows™ operating system. To install the software, extract the zip file to a temporary directory and follow the installation procedure included.

Figure 11 • DSA USB Interface Board



Connection of the USB Interface Board to the Evaluation Board

The evaluation board and the USB interface board contain a keyed 16 pin header. This feature allows the USB interface board (socket) to connect directly to the evaluation board (pin) on the front-side as shown in **Figure 12**.

Figure 12 • USB Interface Board Connected to the Evaluation Board for Latched Parallel and Serial Programming

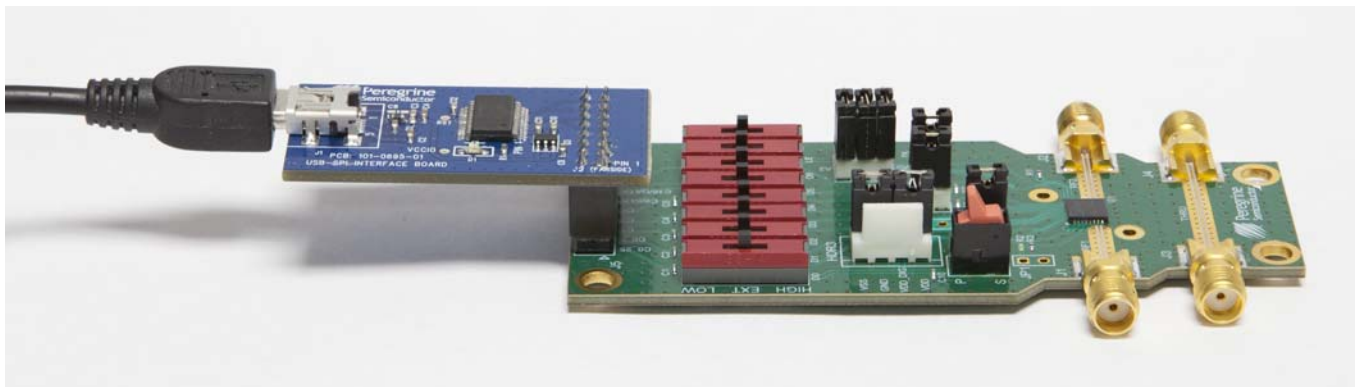

Evaluation Board Overview

The evaluation board is designed to ease customer evaluation of Peregrine's products. The board contains:

- 1) Digital signal connectors that are connected for power supply, digital control signals and USB interface board.
- 2) SMA connectors that are connected for RF performance verification and THRU trace to calibrate board trace loss.

The schematic and evaluation board outline are provided in this user manual.

Figure 13 • PE43713 Evaluation Board Schematic

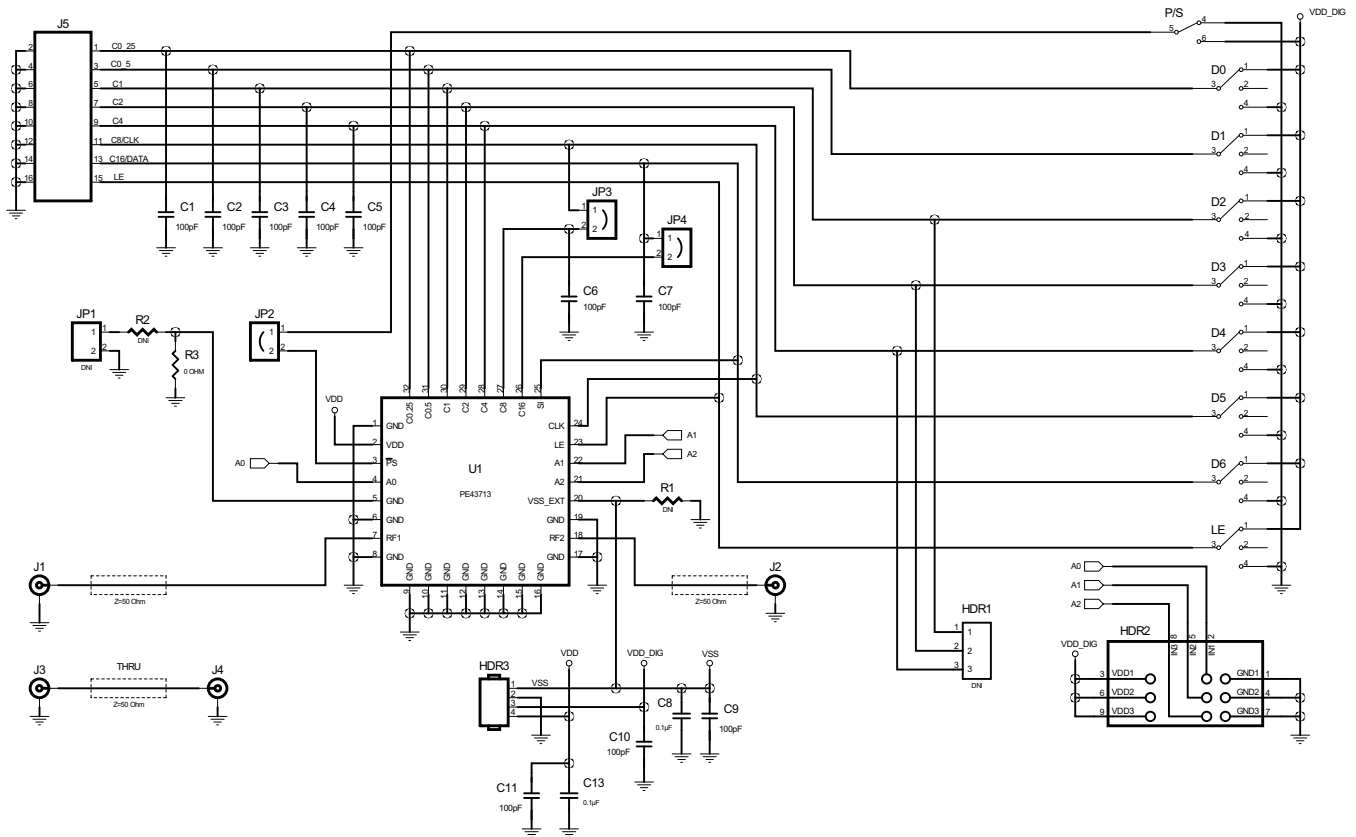
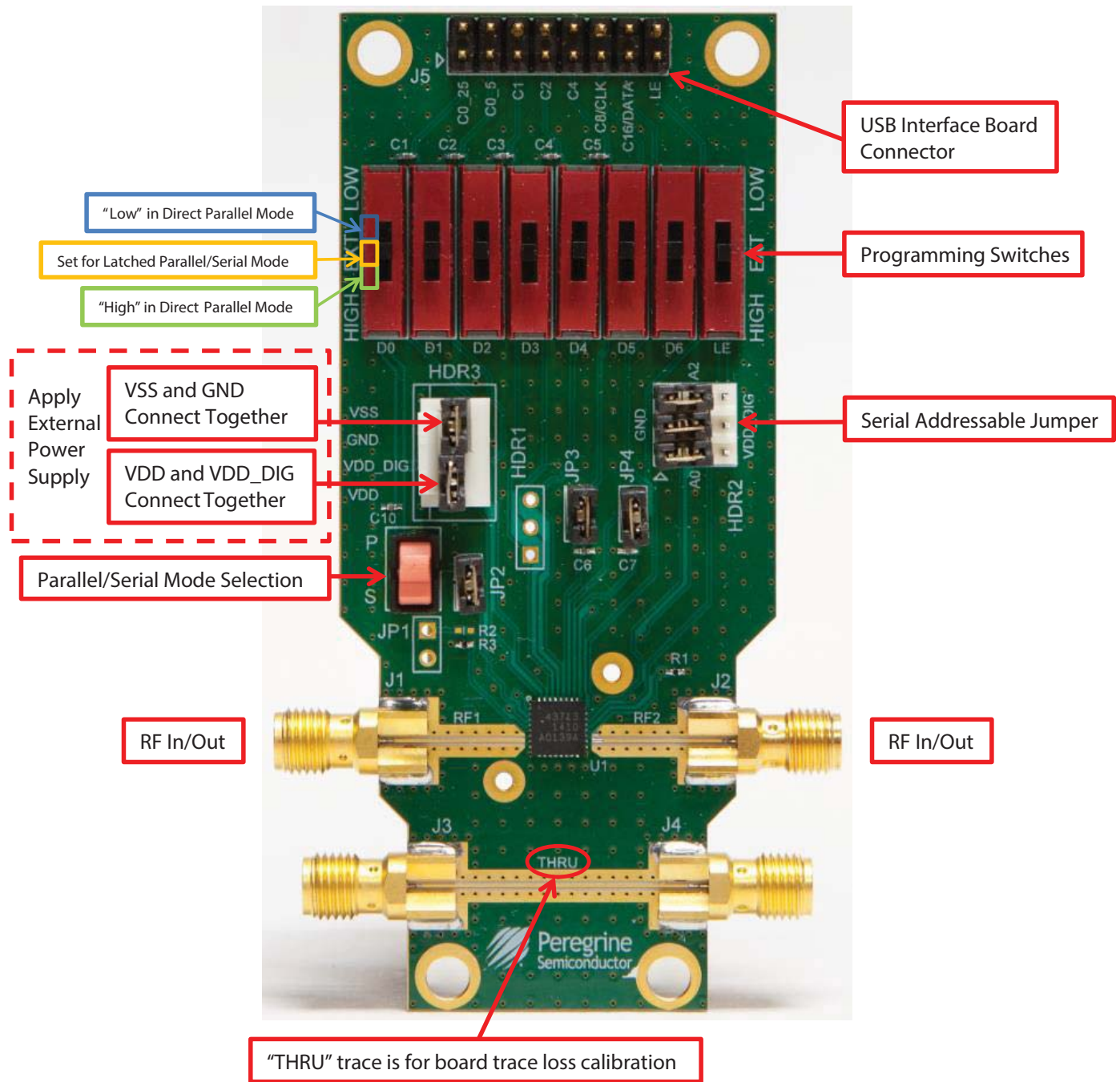

Figure 14 • PE43713 Evaluation Board Outline Showing Functional Overview



Hardware Operation

The general guidelines for operating the hardware evaluation board are listed in this section. Follow the steps below to configure the hardware properly for the performance.

- 1) Verify that all DC power supplies are turned off before proceeding.
- 2) Connect the jumper on JP2, JP3 and JP4.
- 3) Place the three jumpers of HDR2 connecting the middle pin to the GND pin. HDR2 is for the serial-addressable features. Refer to the PE43713 datasheet for more details.
- 4) Position the P/S switch to Parallel or Serial mode.
- 5) Set the D0–D6 and LE mechanical programming switches on the board to support Direct Parallel, Latched Parallel or Serial mode.
 - a) Place D0–D6 and LE at the middle position to support Latched Parallel and Serial modes with GUI application software and proper position of the P/S switch.
 - b) In Direct Parallel mode, D0–D6 can be set to HIGH or LOW to manually program the attenuation state while LE is connected to HIGH without using the USB interface board and GUI application software.
- 6) Provide external power supply to the HDR3 (**Table 2**).
 - a) VDD is the positive power supply with 3.0V typical.
 - b) VDD_DIG is the positive power supply for control signals with 1.8V typical, and it can be connected to V_{DD} with jumper to simplify the test set-up.
 - c) VDD_DIG can be connected to VDD with jumper to simplify the test set-up, VDD_DEG = VDD = 3.0V typical.
 - d) VSS is the external negative power supply for PE43713. It can also be short to GND using the internal negative voltage generator to simplify the test setup.
- 7) Calibrate board trace loss with THRU trace between J3 and J4.

Table 2 • Operating Ranges

Parameter	Min	Typ	Max	Unit
Supply voltage, V _{DD}	2.3		5.5	V
Supply current, I _{DD}		150	200	μA
Digital input high	1.17		3.6	V
Digital input low	–0.3		0.6	V
Digital input current			17.5	μA

Using the Graphical User Interface

Figure 15 displays the DSA application software graphical user interface (GUI), which has the USB interface board plugged into the computer. “**Hardware Operation**” for the EVK hardware configuration to use with the GUI control software. If the USB interface board is not connected when the application software is launched, the message “**No interface board connected! Please connect USB-SPI Interface #101-0695.**” will appear at the bottom of the screen.

In the upper left corner, under the Peregrine logo there is a drop down menu item to select the part for evaluation and the part description is below the part number box.

Figure 15 • DSA Application Software Graphical User Interface

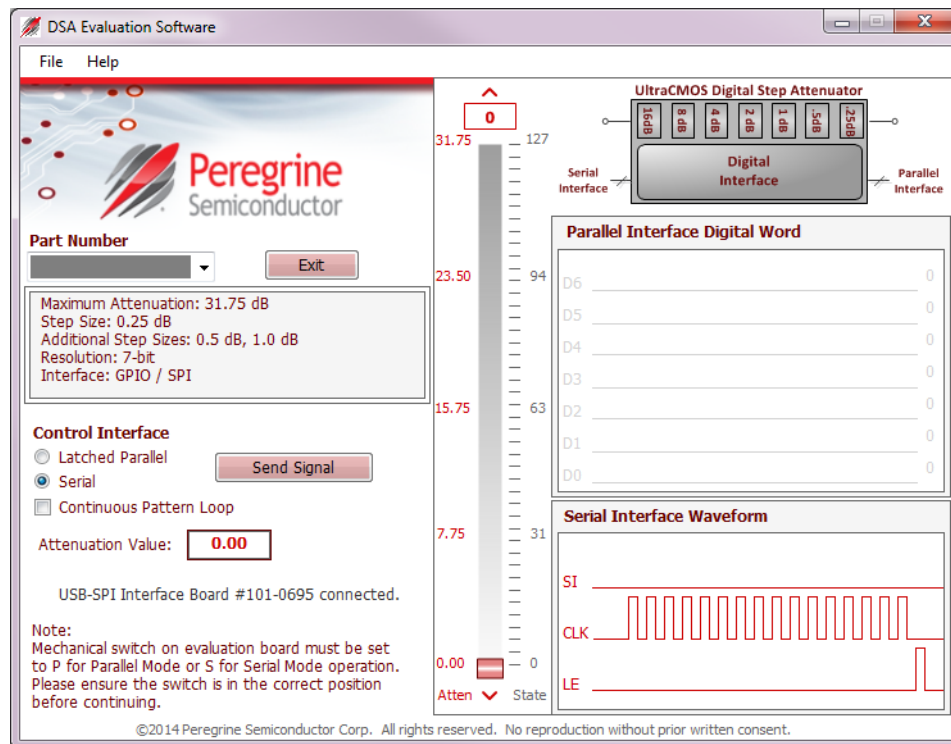

The DSA application software GUI supports Latched Parallel and Serial modes with position of the P/S switch (Table 3), and shows the control bit waveform at the right side of the GUI when the mode is selected.

Table 3 • EVK Jumper/Switch Configuration

Jumper/Switch	GUI Operation		
	Direct Parallel Mode	Latched Parallel Mode	Serial Mode
P/S	P	P	S
LE	HIGH	EXT	EXT
D0	LOW/HIGH	EXT	EXT
D1	LOW/HIGH	EXT	EXT
D2	LOW/HIGH	EXT	EXT
D3	LOW/HIGH	EXT	EXT
D4	LOW/HIGH	EXT	EXT
D5	LOW/HIGH	EXT	EXT
D6	LOW/HIGH	EXT	EXT
JP2	Installed	Installed	Installed
JP3	Installed	Installed	Installed
JP4	Installed	Installed	Installed

The Send button changes functionality based on the control interface mode. Send Latch in Latched Parallel mode and Send Signal in Serial mode are provided to resend the programming bits to the device at the same attenuation state.

Figure 16 • Latched Parallel or Serial Mode

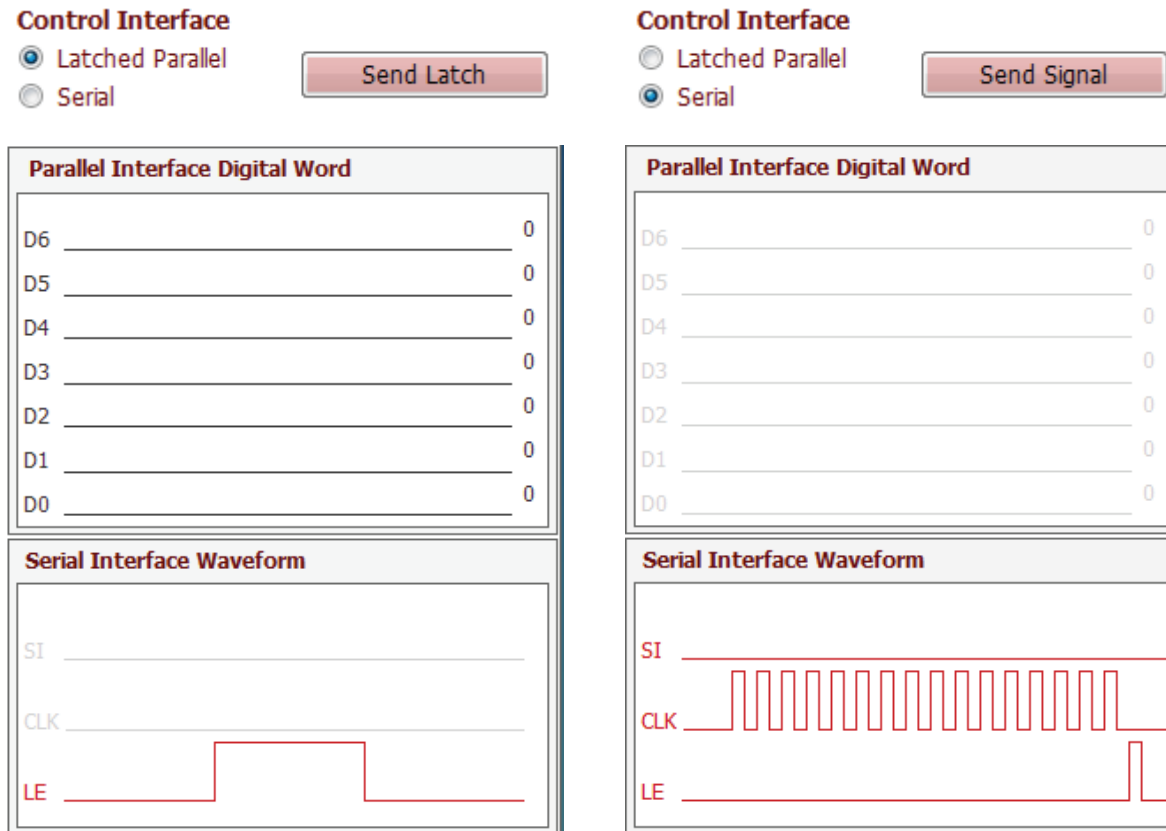

Continuous Pattern Loop can be selected to automatically step through each of the attenuation states.

Figure 17 • Continuous Pattern Loop

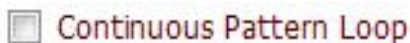

The Attenuation Value box displays the attenuation value the DSA is currently programmed to. The user can enter the desired attenuation value followed by the “Enter” key to program the DSA.

Figure 18 • Attenuation Value



The center of the GUI is the attenuation slide bar that allows the user to quickly select the desired attenuation. The arrows at the top and bottom can be clicked to increase or decrease attenuation state at the minimum step size.

Figure 19 • Attenuation Slide Bar

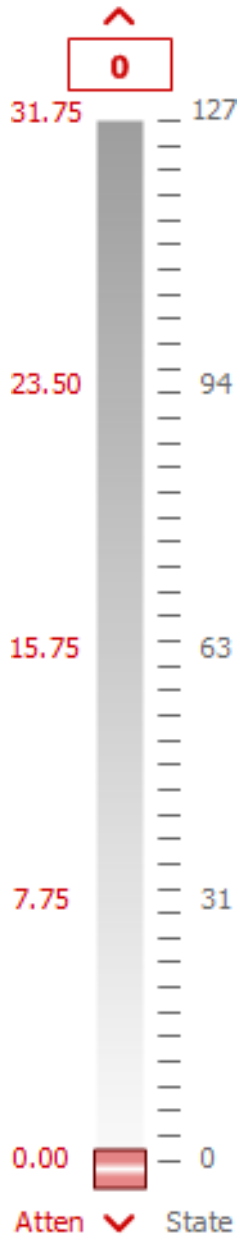

Technical Resources



Technical Resources

Additional technical resources are available for download in the Products section at www.psemi.com. These include the Product Specification datasheet, S-parameters zip file, evaluation kit schematic and bill of materials, material declaration form and PC-compatible software file.

Trademarks are subject to trademark claims.

Document Categories

Advance Information

The product is in a formative or design stage. The datasheet contains design target specifications for product development. Specifications and features may change in any manner without notice.

Preliminary Specification

The datasheet contains preliminary data. Additional data may be added at a later date. Peregrine reserves the right to change specifications at any time without notice in order to supply the best possible product.

Product Specification

The datasheet contains final data. In the event Peregrine decides to change the specifications, Peregrine will notify customers of the intended changes by issuing a CNF (Customer Notification Form).

Not Recommended for New Designs (NRND)

This product is in production but is not recommended for new designs.

End of Life (EOL)

This product is currently going through the EOL process. It has a specific last-time buy date.

Obsolete

This product is discontinued. Orders are no longer accepted for this product.

