

## GT3-WW

~45° wide beam

### TECHNICAL SPECIFICATIONS:

Dimensions	Ø 35 mm
Height	9 mm
Fastening	glue, pin
Colour	clear
Box size	254 x 298 x 241 mm
Box weight	4.5 kg
Quantity in Box	864 pcs
ROHS compliant	yes ⓘ



### MATERIAL SPECIFICATIONS:

Component	Type	Material	Colour
GT3-WW	Lens array	PMMA	clear

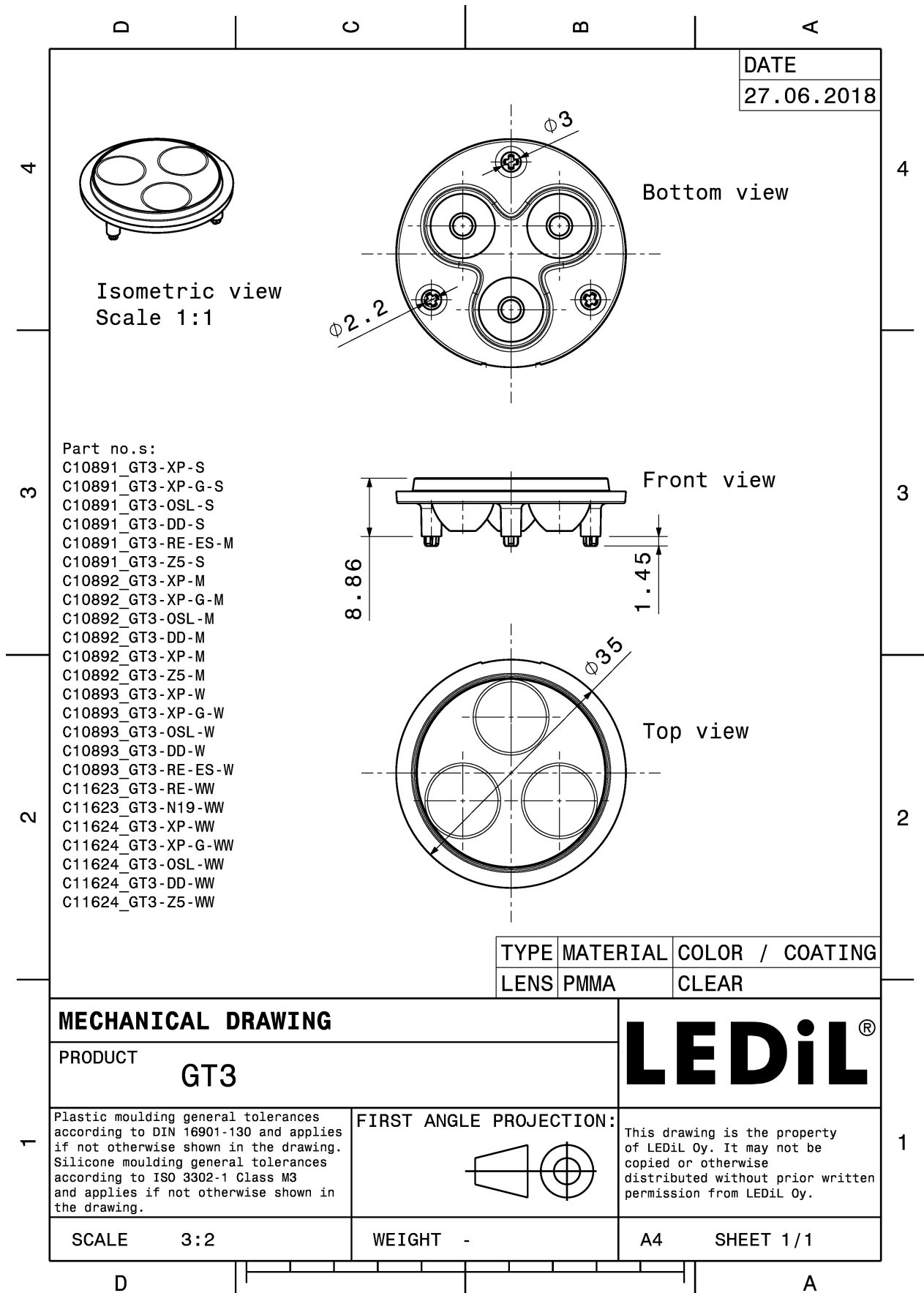

### PHOTOMETRIC DATA (MEASURED):

#### CREE

LED XB-D  
FWHM 38.0°  
Efficiency 92 %  
Peak intensity 1.400 cd/lm  
Required components:

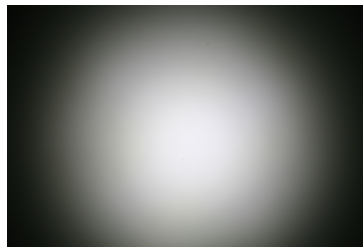

#### CREE

LED XP-E  
FWHM 61.0°  
Efficiency 90 %  
Peak intensity 0.760 cd/lm  
Required components:

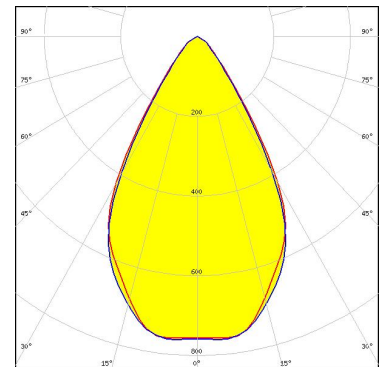
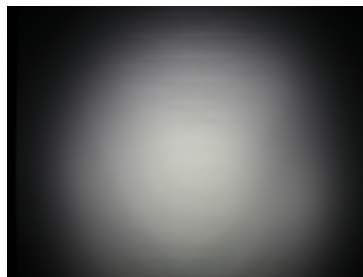

#### CREE

LED XP-G  
FWHM 59.0°  
Efficiency 90 %  
Peak intensity 0.860 cd/lm  
Required components:

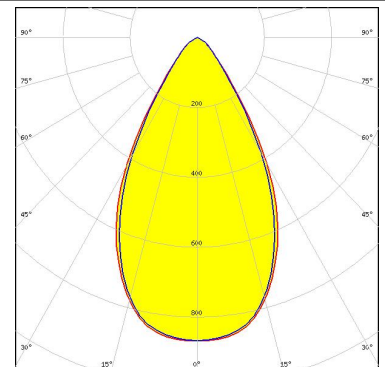
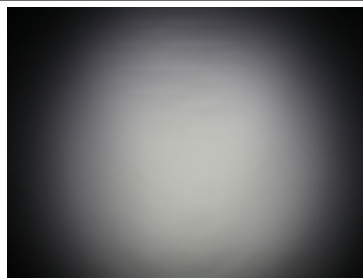

#### LUMILEDS

LED LUXEON A  
FWHM 42.0°  
Efficiency %  
Peak intensity cd/lm  
Required components:

#### PHOTOMETRIC DATA (MEASURED):



LED LUXEON Rebel  
 FWHM 46.0°  
 Efficiency 89 %  
 Peak intensity cd/lm  
 Required components:

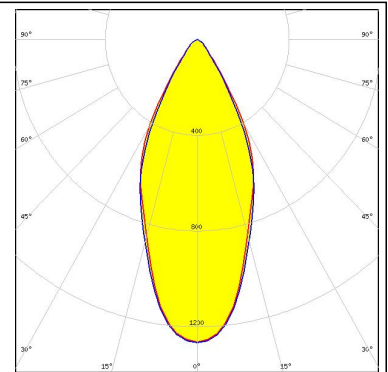
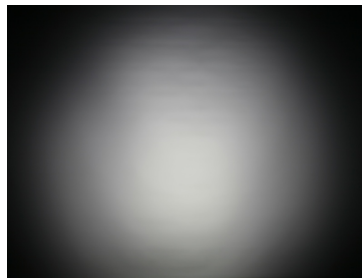

LED LUXEON Rebel ES  
 FWHM 42.0°  
 Efficiency 92 %  
 Peak intensity cd/lm  
 Required components:

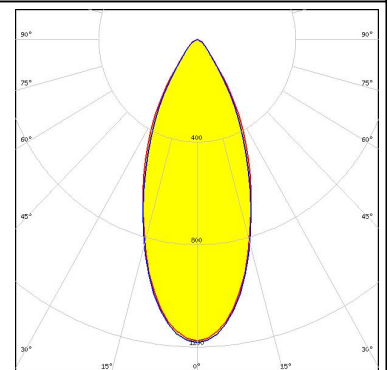
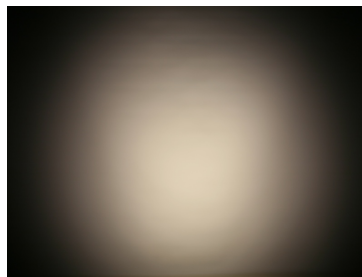

LED Oslon Square EC  
 FWHM 35.0°  
 Efficiency 91 %  
 Peak intensity 1.470 cd/lm  
 Required components:

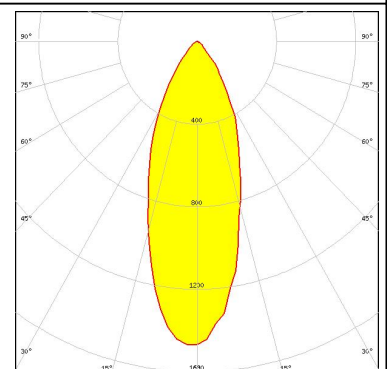

LED Oslon SSL 150  
 FWHM 48.0°  
 Efficiency 87 %  
 Peak intensity 1.100 cd/lm  
 Required components:

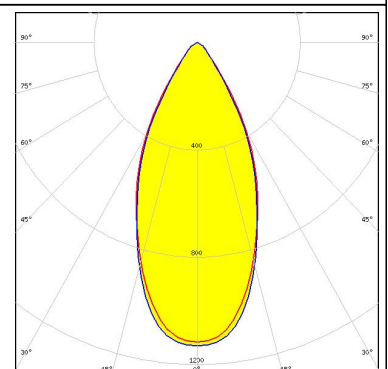
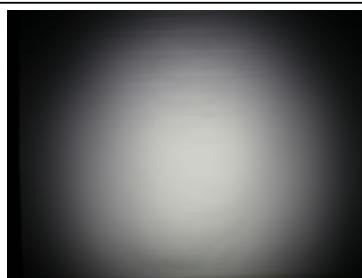

## PHOTOMETRIC DATA (MEASURED):

**OSRAM**  
Opto Semiconductors

LED            Oslon SSL 80  
FWHM        54.0°  
Efficiency    91 %  
Peak intensity 0.940 cd/lm  
Required components:

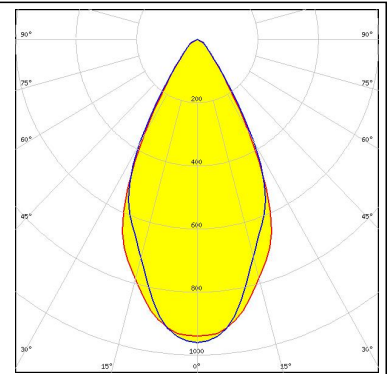

## PHOTOMETRIC DATA (SIMULATED):



LED                    NCSxx19A  
FWHM                50.0°  
Efficiency            92 %  
Peak intensity      cd/lm  
Required components:



LED                    NVSxx19A  
FWHM                50.0°  
Efficiency            92 %  
Peak intensity      cd/lm  
Required components:

### GENERAL INFORMATION:

NOTE: The typical beam angle will be changed by different color, chip size and chip position tolerance. The typical total beam angle is the full angle measured where the luminous intensity is half of the peak value.

### MATERIALS:

As part of our continuous research and improvement processes, and to ensure the best possible quality and availability of our products, LEDiL reserves the right to change material grades without notice.

### PRODUCT DATA USER AGREEMENT AND DISCLAIMER:

The measured data in the provided downloadable LEDiL Product Datasheets and Mechanical 2D-Drawings is rounded and provided as reference for planning. LEDiL Oy's optical specifications have been verified by conducting performance testing of the products in accordance with the company's quality system. The reported data are averaged results of multiple measurements with typical variation. LEDiL Oy reserves the right to without prior notification make changes and improvements to its products.

LEDiL Oy assumes neither warranty, nor guarantee nor any other liability of any kind for the contents and correctness of the provided data. The provided data has been generated with highest diligence but the provided data may in reality not represent the complete possible variation range of all intrinsic parameters. Therefore, in certain cases a deviation from the provided data could occur.

LEDiL Oy reserves the right to undertake technical changes of its products without further notification which could lead to changes in the provided data. LEDiL Oy assumes no liability of any kind for the possible deviation from any provided data or any other damage resulting from the usage of the provided data.

The user agrees to this disclaimer and user agreement with the download or usage of the provided files.

#### LEDiL Oy

Joensuunkatu 13  
FI-24240 SALO  
Finland

#### LEDiL Inc.

228 West Page Street  
Suite D  
Sycamore IL 60178  
USA

#### Local sales and technical support

[www.ledil.com/  
where\\_to\\_buy](http://www.ledil.com/where_to_buy)

#### Shipping locations

Salo, Finland  
Hong Kong, China

#### Distribution Partners

[www.ledil.com/  
where\\_to\\_buy](http://www.ledil.com/where_to_buy)