

MAXIM

Low Power Fast CMOS Analog Switches

IH5140/41/42/43/44/45

General Description

The IH5140 family consists of six CMOS analog switches that are intended for high speed general purpose applications. These switches are latch-up proof, break-before-make single and dual versions of all the popular switch formats — SPST, SPDT, and DPST. Key features of the family include toggle rates in excess of 1MHz, t_{ON} times of 80ns typical and t_{OFF} times of 50ns. OFF leakage current is less than 100pA maximum at +25°C and quiescent currents are 1μA maximum, making the switches ideal for portable equipment.

Maxim has significantly improved the design of these switches versus the original manufacturer. Maxim's switches are guaranteed to operate from ±4.5V to ±18V, and will switch input signals that include the supplies.

Applications

- High Speed Test Equipment
- Sample and Hold Circuits
- Guidance and Control Systems
- Radar Systems
- Aircraft Head-Up Displays
- Military Radios

Typical Operating Circuit

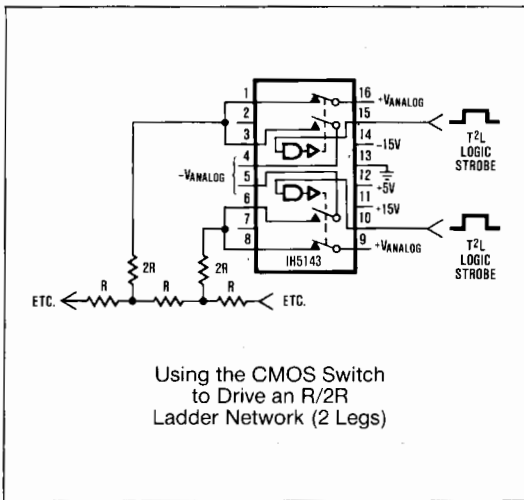

Features

- ◆ Pin for Pin 2nd Source!
- ◆ Break-Before-Make Switching Action
- ◆ Fast t_{ON} (80ns typ.) and t_{OFF} (50ns)
- ◆ Input Signal Range Includes Supply Rails
- ◆ Guaranteed ±4.5V to ±18V Operation
- ◆ Low OFF Leakage Current — 100pA max.
- ◆ Greater than 1MHz Toggle Rate
- ◆ TTL and CMOS Compatible

Ordering Information

| PART | TEMP. RANGE | PACKAGE |
|--------------------------------------------------|-----------------|---------------------|
| SINGLE POLE SINGLE THROW (SPST) | | |
| IH5140C/D | 0°C to +70°C | DICE |
| IH5140CJE | 0°C to +70°C | 16 Lead CERDIP |
| IH5140CPE | 0°C to +70°C | 16 Lead Plastic DIP |
| IH5140CWE | 0°C to +70°C | 16 Lead Wide SO |
| IH5140M/D | -55°C to +125°C | DICE |
| IH5140MJE | -55°C to +125°C | 16 Lead CERDIP |
| DUAL SINGLE POLE SINGLE THROW (DUAL SPST) | | |
| IH5141C/D | 0°C to +70°C | DICE |
| IH5141CJE | 0°C to +70°C | 16 Lead CERDIP |
| IH5141CPE | 0°C to +70°C | 16 Lead Plastic DIP |
| IH5141CTW | 0°C to +70°C | 10 Lead Metal Can |
| IH5141CWE | 0°C to +70°C | 16 Lead Wide SO |
| IH5141M/D | -55°C to +125°C | DICE |
| IH5141MJE | -55°C to +125°C | 16 Lead CERDIP |
| IH5141MTW | -55°C to +125°C | 10 Lead Metal Can |
| SINGLE POLE DOUBLE THROW (SPDT) | | |
| IH5142C/D | 0°C to +70°C | DICE |
| IH5142CJE | 0°C to +70°C | 16 Lead CERDIP |
| IH5142CPE | 0°C to +70°C | 16 Lead Plastic DIP |
| IH5142CWE | 0°C to +70°C | 16 Lead Wide SO |
| IH5142M/D | -55°C to +125°C | DICE |
| IH5142MJE | -55°C to +125°C | 16 Lead CERDIP |
| DUAL SINGLE POLE DOUBLE THROW (DUAL SPDT) | | |
| IH5143C/D | 0°C to +70°C | DICE |
| IH5143CJE | 0°C to +70°C | 16 Lead CERDIP |
| IH5143CPE | 0°C to +70°C | 16 Lead Plastic DIP |
| IH5143CWE | 0°C to +70°C | 16 Lead Wide SO |
| IH5143M/D | -55°C to +125°C | DICE |
| IH5143MJE | -55°C to +125°C | 16 Lead CERDIP |

(Ordering information continued on fourth page.)

MAXIM

Maxim Integrated Products 1

Call toll free 1-800-998-8800 for free samples or literature.

Low Power Fast CMOS Analog Switches

ABSOLUTE MAXIMUM RATINGS

| | | | |
|--------------------------------------------|-----------------|----------------------|-------------------------------------|
| Current (Any Terminal) | < 30mA | $V_D - V^-$ | < 30V |
| Storage Temperature | -65°C to +150°C | $V_D - V_S$ | < ±22V |
| Operating Temperature | -55°C to +125°C | $V_L - V^-$ | < 33V |
| Power Dissipation | 450mW | $V_L - V_{IN}$ | < 30V |
| (All Leads Soldered to a P.C. Board) | | $V_L - GND$ | < 20V |
| Derate 6mW/°C Above +70°C | | $V_{IN} - GND$ | < 20V |
| Lead Temperature (Soldering, 10 sec) | 300°C | Digital Inputs | ($V^+ + 0.3V$) to ($V^+ - 38V$) |
| Voltages | | V_S or V_D | -0.3V to ($V^+ + 0.3V$) (Note 1) |
| $V^+ - V^-$ | < 38V | | |
| $V^+ - V_D$ | < 30V | | |

Note 1: Signals on S, D and digital inputs which exceed V^- or V^+ will be clamped by internal diodes. Limit forward diode current to 30mA maximum.

Stresses above those listed under "Absolute Maximum Ratings" may cause permanent damage to the device. These are stress ratings only and functional operation of the device at these or any other conditions above those indicated in the operational sections of the specifications is not implied. Exposure to absolute maximum rating conditions for extended periods may affect device reliability.

ELECTRICAL CHARACTERISTICS

(All Parameters with $V^+ = +15V$, $V^- = -15V$, $V_L = +5V$, unless otherwise indicated)

| PARAMETER | SYMBOL | TEST CONDITIONS | MIN./MAX. LIMITS | | | | | | UNITS |
|-----------------------------------------------------------------|--------------------------------|-------------------------------------------------------------|--------------------------------------------------------|-------|--------|--------------------------------|-------|-------|-------|
| | | | MILITARY | | | COMMERCIAL | | | |
| | | | -55°C | +25°C | +125°C | 0°C | +25°C | +70°C | |
| Input Logic Current | I_{INH} | $V_{IN} = 2.4V$ (Note 2) | ±1 | ±1 | 10 | +1 | ±1 | 10 | μA |
| Input Logic Current | I_{INL} | $V_{IN} = 0.8V$ (Note 2) | +1 | ±1 | 10 | ±1 | ±1 | 10 | μA |
| Drain-Source On Resistance | $r_{DS(ON)}$ | $I_S = -10mA$ $V_{ANALOG} = -10V$ to +10V | 50 | 50 | 75 | 75 | 75 | 100 | Ω |
| Channel to Channel $r_{DS(ON)}$ Match | $\Delta r_{DS(ON)}$ | | 3 (typ) | | | 5 (typ) | | | Ω |
| Minimum Analog Signal Handling Capability | V_{ANALOG} | | +15 | | | ±15 | | | V |
| Switch OFF Leakage Current | $I_{D(OFF)}$ + $I_{S(OFF)}$ | $V_D = +10V$, $V_S = -10V$ $V_D = -10V$, $V_S = +10V$ | ±0.5 | ±0.5 | 100 | ±5 | ±5 | 100 | nA |
| Switch ON Leakage Current | $I_{D(ON)}$ + $I_{S(ON)}$ | $V_D = V_S = -10V$ to +10V | ±1 | ±1 | 200 | +2 | +2 | 200 | nA |
| Switch "ON" Time Switch "OFF" Time | t_{ON} t_{OFF} | | See switching time specifications and timing diagrams. | | | | | | |
| Charge Injection | $Q_{(INJ)}$ | (Note 3) | 10 (typ) | | | 15 (typ) | | | pC |
| Minimum Off Isolation Rejection Ratio | OIRR | $f = 1MHz$, $R_L = 100\Omega$, $C_L \leq 5pF$ (Note 3) | 54 (typ) | | | 50 (typ) | | | dB |
| + Power Supply Quiescent Current | I^+ | $V^+ = +15V$, $V^- = -15V$, $V_L = +5V$ | 1.0 | 1.0 | 10.0 | 10 | 10 | 100 | μA |
| - Power Supply Quiescent Current | I^- | | -1.0 | -1.0 | -10.0 | -10 | -10 | -100 | μA |
| +5V Supply Quiescent Current | I_L | | 1.0 | 1.0 | 10.0 | 10 | 10 | 100 | μA |
| Ground Supply Quiescent Current | I_{GND} | | 1.0 | 1.0 | 10.0 | 10 | 10 | 100 | μA |
| Minimum Channel to Channel Cross Coupling Rejection Ratio | CCRR | One Channel Off (Note 3) | 54 (typ) | | | 50 (typ) | | | dB |
| Power Supply Range for Continuous Operation | V_{OP} | (Note 4) | ±4.5 (min) ±18V (max) | | | ±4.5 (min) ±18V (max) | | | V |

Note: 2. Some channels are turned on by high (1) logic inputs and other channels are turned on by low (0) inputs; however, 0.8V to 2.4V describes the minimum range for switching properly. Refer to logic diagrams to find logical value of logic input required to produce ON or OFF state.

3. Typical values are for design aid only, not guaranteed and not subject to production testing.

4. Electrical characteristics, such as ON Resistance, will change when power supplies, other than ±15V, are used.

Low Power Fast CMOS Analog Switches

IH5140/41/42/43/44/45

SWITCHING TIME SPECIFICATIONS

(t_{on} , t_{off} are maximum specifications and $t_{on-t_{off}}$ is minimum specifications)

| PART NUMBER | CHARACTERISTICS | SYMBOL | TEST CONDITIONS | MILITARY | | | COMMERCIAL | | | UNITS |
|-------------------|-------------------|------------------|-----------------|----------|---------|--------|------------|-------|-------|-------|
| | | | | -55°C | +25°C | +125°C | 0°C | +25°C | +70°C | |
| IH5140-5141 | Switch "ON" time | t_{on} | Figure 1 | | 100* | | | 150 | | ns |
| | Switch "OFF" time | t_{off} | | | 75* | | | 125 | | |
| | Break-before-make | $t_{on-t_{off}}$ | | | 10* TYP | | | 5 | | |
| IH5142-5143 | Switch "ON" time | t_{on} | Figure 1 | | 175* | | | 250 | | ns |
| | Switch "OFF" time | t_{off} | | | 125* | | | 150 | | |
| | Break-before-make | $t_{on-t_{off}}$ | Figure 2 | | 10* TYP | | | 5 | | |
| | Switch "ON" time | t_{on} | | | 200 | | | 300 | | ns |
| Switch "OFF" time | t_{off} | Figure 3 | | 125 | | | 150 | | | |
| Break-before-make | $t_{on-t_{off}}$ | | | 10* TYP | | | 5 | | | |
| IH5144-5145 | Switch "ON" time | t_{on} | Figure 1 | | 175* | | | 250 | | ns |
| | Switch "OFF" time | t_{off} | | | 125* | | | 150 | | |
| | Break-before-make | $t_{on-t_{off}}$ | Figure 2 | | 10* TYP | | | 5 | | |
| | Switch "ON" time | t_{on} | | | 200 | | | 300 | | ns |
| Switch "OFF" time | t_{off} | Figure 2 | | 125 | | | 150 | | | |
| Break-before-make | $t_{on-t_{off}}$ | | | 10* TYP | | | 5 | | | |

Note: Switching times are measured at 90% points.
 * Guaranteed but not subjected to production testing.

Switching Time Test Circuits

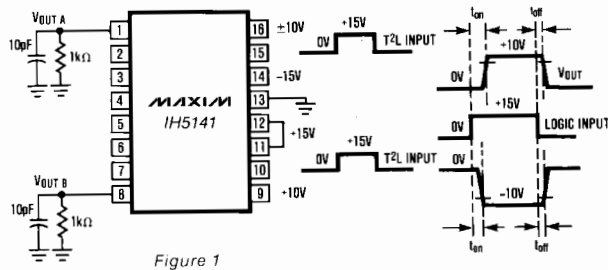

Figure 1

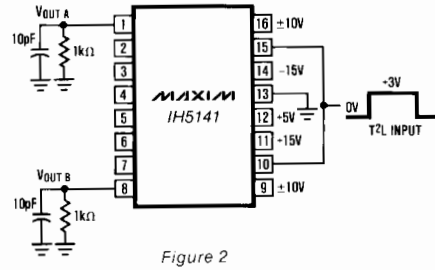

Figure 2

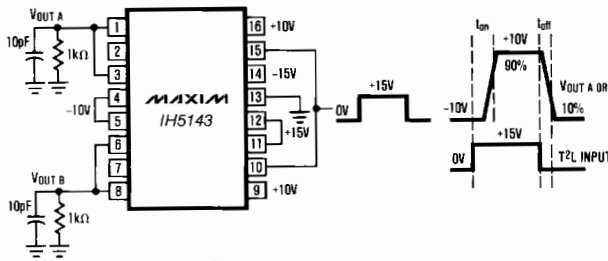

Figure 3

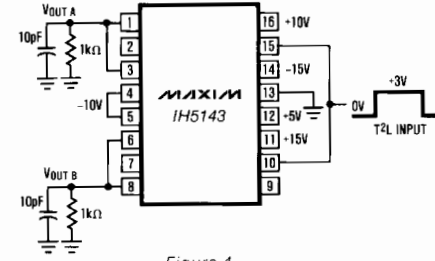

Figure 4

Low Power Fast CMOS Analog Switches

Pin Configuration and Switching State Diagrams

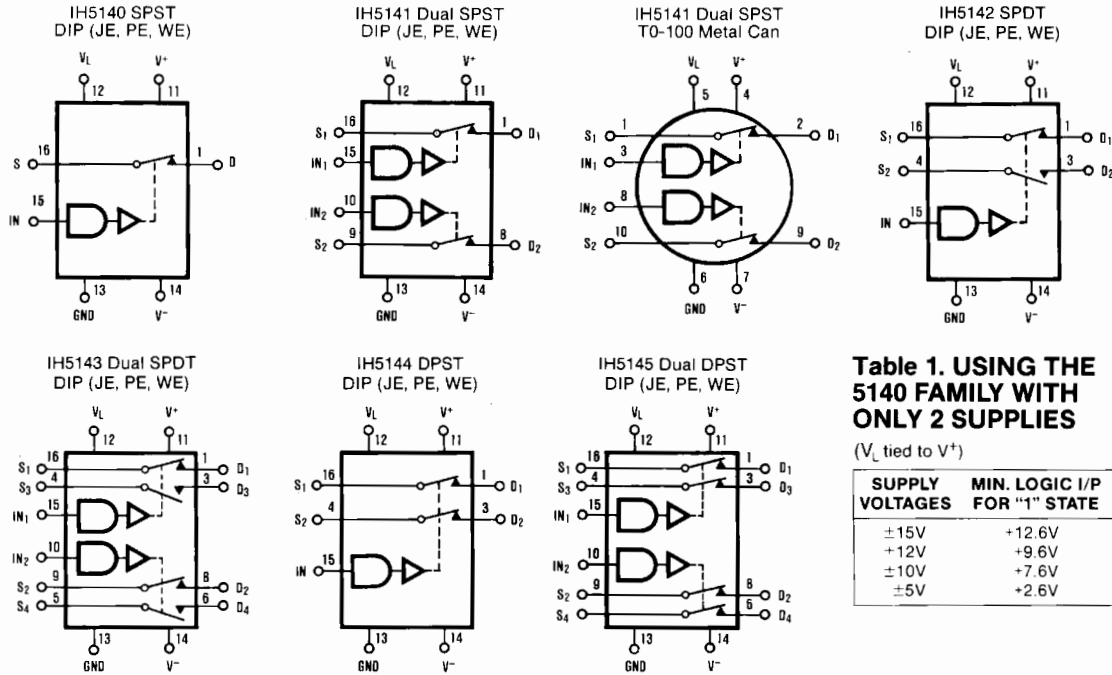

Table 1. USING THE 5140 FAMILY WITH ONLY 2 SUPPLIES

(V_L tied to V^+)

| SUPPLY VOLTAGES | MIN. LOGIC I/P FOR "1" STATE |
|-----------------|------------------------------|
| $\pm 15V$ | +12.6V |
| +12V | +9.6V |
| $\pm 10V$ | +7.6V |
| $\pm 5V$ | +2.6V |

Note: Switch states are for logic "1" input.

Ordering Information (continued)

| PART | TEMP. RANGE | PACKAGE |
|--------------------------------------------------|-----------------|---------------------|
| DOUBLE POLE SINGLE THROW (DPST) | | |
| IH5144C/D | 0°C to +70°C | DICE |
| IH5144CJE | 0°C to +70°C | 16 Lead CERDIP |
| IH5144CPE | 0°C to +70°C | 16 Lead Plastic DIP |
| IH5144CWE | 0°C to +70°C | 16 Lead Wide SO |
| IH5144M/D | -55°C to +125°C | DICE |
| IH5144MJE | -55°C to +125°C | 16 Lead CERDIP |
| DUAL DOUBLE POLE SINGLE THROW (DUAL DPST) | | |
| IH5145C/D | 0°C to +70°C | DICE |
| IH5145CJE | 0°C to +70°C | 16 Lead CERDIP |
| IH5145CPE | 0°C to +70°C | 16 Lead Plastic DIP |
| IH5145CWE | 0°C to +70°C | 16 Lead Wide SO |
| IH5145M/D | -55°C to +125°C | DICE |
| IH5145MJE | -55°C to +125°C | 16 Lead CERDIP |

For the IH5142 and IH5144 in 10 Lead Metal Can package contact factory. For all devices in Ceramic Flat Package contact factory.

Chip Topography

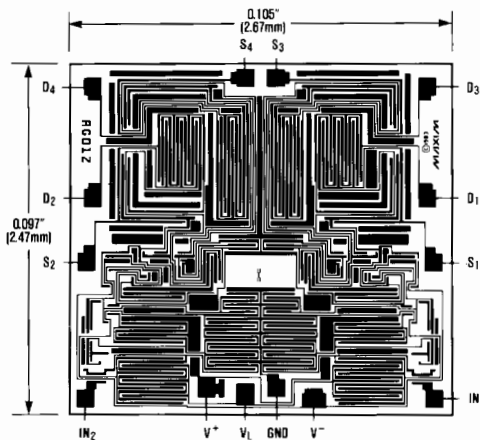

Maxim cannot assume responsibility for use of any circuitry other than circuitry entirely embodied in a Maxim product. No circuit patent licenses are implied. Maxim reserves the right to change the circuitry and specifications without notice at any time.

4 Maxim Integrated Products, 120 San Gabriel Drive, Sunnyvale, CA 94086 (408) 737-7600