

Automotive-grade dual N-channel 40 V, 8 mΩ typ., 15 A STripFET™ F5 Power MOSFET in a PowerFLAT™ 5x6 DI

Datasheet - production data

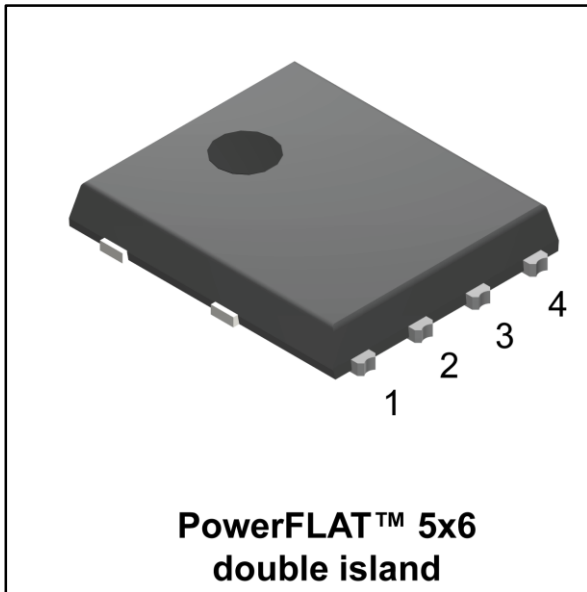

Figure 1: Internal schematic diagram

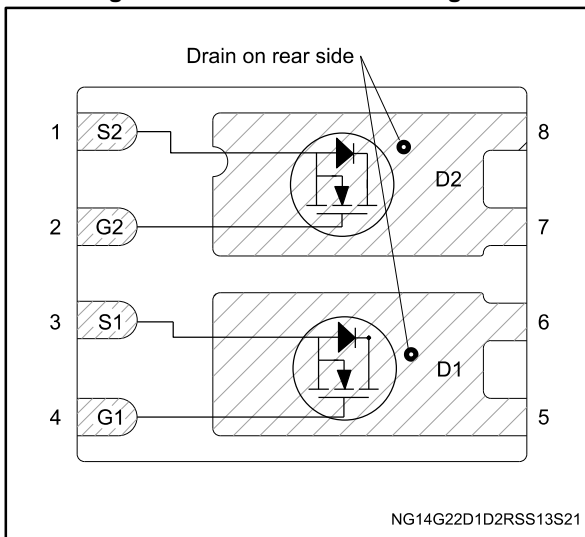

Table 1: Device summary

Order code	Marking	Package	Packing
STL15DN4F5	15DN4F5	PowerFLAT™ 5x6 double island	Tape and reel

Features

Order code	V _{DS}	R _{DS(on)} max.	I _D
STL15DN4F5	40 V	9 mΩ	15 A

- Designed for automotive applications and AEC-Q101 qualified
- Extremely low R_{DS(on)}
- Very low gate charge
- Low gate drive power loss
- Wettable flank package

Applications

- Switching applications

Description

This device is a dual N-channel Power MOSFET developed using STMicroelectronics' STripFET™ F5 technology. The device has been optimized to achieve very low on-state resistance, contributing to a FoM that is among the best in its class.

Contents

1	Electrical ratings	3
2	Electrical characteristics	4
	2.1 Electrical characteristics (curves)	6
3	Test circuits	8
4	Package information	9
	4.1 PowerFLAT 5x6 double island WF type C package information	10
	4.2 Packing information.....	13
5	Revision history	15

1 Electrical ratings

Table 2: Absolute maximum ratings

Symbol	Parameter	Value	Unit
V_{DS}	Drain-source voltage	40	V
V_{GS}	Gate-source voltage	± 20	V
$I_D^{(1)}$	Drain current (continuous) at $T_C = 25\text{ }^\circ\text{C}$	60	A
$I_D^{(2)}$	Drain current (continuous) at $T_{pcb} = 25\text{ }^\circ\text{C}$	15	A
$I_D^{(2)}$	Drain current (continuous) at $T_{pcb} = 100\text{ }^\circ\text{C}$	10	A
$I_{DM}^{(2)(3)}$	Drain current (pulsed)	60	A
$P_{TOT}^{(1)}$	Total dissipation at $T_C = 25\text{ }^\circ\text{C}$	60	W
$P_{TOT}^{(2)}$	Total dissipation at $T_{pcb} = 25\text{ }^\circ\text{C}$	4.3	W
T_j	Operating junction temperature range	-55 to 175	$^\circ\text{C}$
T_{stg}	Storage temperature range		

Notes:

- (1)The value is rated according R_{thj-c} .
 (2)The value is rated according $R_{thj-pcb}$.
 (3)Pulse width limited by safe operating area.

Table 3: Thermal resistance

Symbol	Parameter	Value	Unit
$R_{thj-case}$	Thermal resistance junction-case	2.5	$^\circ\text{C/W}$
$R_{thj-pcb}^{(1)}$	Thermal resistance junction-pcb	35	$^\circ\text{C/W}$

Notes:

- (1)When mounted on FR-4 board of 1 inch², 2oz Cu, $t < 10\text{ }s$.

Table 4: Avalanche data

Symbol	Parameter	Value	Unit
I_{AV}	Not-repetitive avalanche current, (pulse width limited by T_j max.)	7.5	A
$E_{AS}^{(1)}$	Single pulse avalanche energy (starting $T_J = 25\text{ }^\circ\text{C}$, $I_D = I_{AV}$, $V_{DD} = 24\text{ V}$)	150	mJ

Notes:

- (1)Tested at wafer level only.

2 Electrical characteristics

($T_C = 25\text{ }^\circ\text{C}$ unless otherwise specified)

Table 5: On/Off states

Symbol	Parameter	Test conditions	Min.	Typ.	Max.	Unit
$V_{(BR)DSS}$	Drain-source breakdown voltage	$I_D = 250\text{ }\mu\text{A}$, $V_{GS} = 0\text{ V}$	40			V
I_{DSS}	Zero gate voltage drain current	$V_{GS} = 0\text{ V}$, $V_{DS} = 40\text{ V}$			1	μA
		$V_{GS} = 0\text{ V}$, $V_{DS} = 40\text{ V}$, $T_C = 125\text{ }^\circ\text{C}$ ⁽¹⁾			10	μA
I_{GSS}	Gate-body leakage current	$V_{GS} = \pm 20\text{ V}$, $V_{DS} = 0\text{ V}$			± 100	nA
$V_{GS(th)}$	Gate threshold voltage	$V_{DS} = V_{GS}$, $I_D = 250\text{ }\mu\text{A}$	2		4	V
$R_{DS(on)}$	Static drain-source on-resistance	$V_{GS} = 10\text{ V}$, $I_D = 7.5\text{ A}$		8	9	m Ω

Notes:

⁽¹⁾Defined by design, not subject to production test

Table 6: Dynamic

Symbol	Parameter	Test conditions	Min.	Typ.	Max.	Unit
C_{iss}	Input capacitance	$V_{DS} = 25\text{ V}$, $f = 1\text{ MHz}$, $V_{GS} = 0\text{ V}$	-	1550	-	pF
C_{oss}	Output capacitance		-	230	-	
C_{rss}	Reverse transfer capacitance		-	25	-	
Q_g	Total gate charge	$V_{DD} = 20\text{ V}$, $I_D = 15\text{ A}$, $V_{GS} = 10\text{ V}$ (see Figure 14: "Test circuit for gate charge behavior")	-	25	-	nC
Q_{gs}	Gate-source charge		-	6	-	
Q_{gd}	Gate-drain charge		-	5.5	-	

Table 7: Switching times

Symbol	Parameter	Test conditions	Min.	Typ.	Max.	Unit
$t_{d(on)}$	Turn-on delay time	$V_{DD} = 20\text{ V}$, $I_D = 7.5\text{ A}$, $R_G = 4.7\text{ }\Omega$, $V_{GS} = 10\text{ V}$ (see Figure 13: "Test circuit for resistive load switching times")	-	18	-	ns
t_r	Rise time		-	45	-	
$t_{d(off)}$	Turn-off delay time		-	32	-	
t_f	Fall time		-	5	-	

Table 8: Source-drain diode

Symbol	Parameter	Test conditions	Min.	Typ.	Max.	Unit
I_{SD}	Forward on voltage		-		15	A
$I_{SDM}^{(1)}$	Source-drain current (pulsed)		-		60	A
$V_{SD}^{(2)}$	Forward on voltage	$V_{GS} = 0, I_{SD} = 15 \text{ A}$	-		1.1	V
t_{rr}	Reverse recovery time	$I_{SD} = 15 \text{ A}, di/dt = 100 \text{ A}/\mu\text{s}$	-	30		ns
Q_{rr}	Reverse recovery charge	$V_{DD} = 32 \text{ V}, T_j = 150 \text{ }^\circ\text{C}$ (see Figure 15: "Test circuit for inductive load switching and diode recovery times")	-	35		nC
I_{RRM}	Reverse recovery current		-	2.2		A

Notes:

⁽¹⁾Pulse width limited by safe operating area

⁽²⁾Pulsed: pulse duration = 300 μs , duty cycle 1.5 %

2.2 Electrical characteristics (curves)

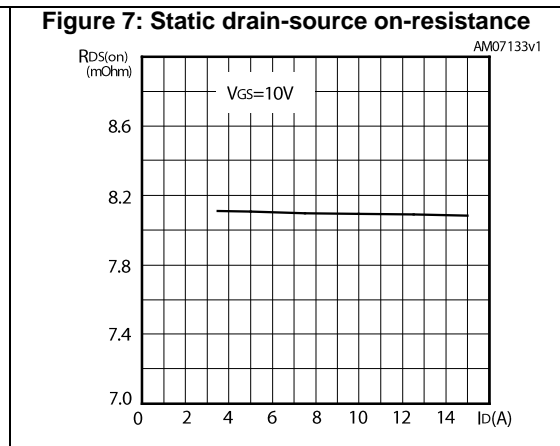
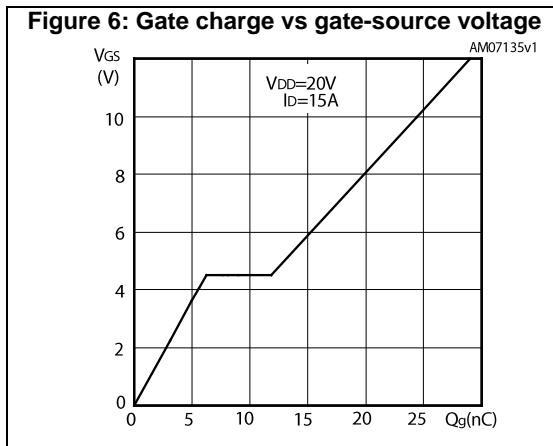
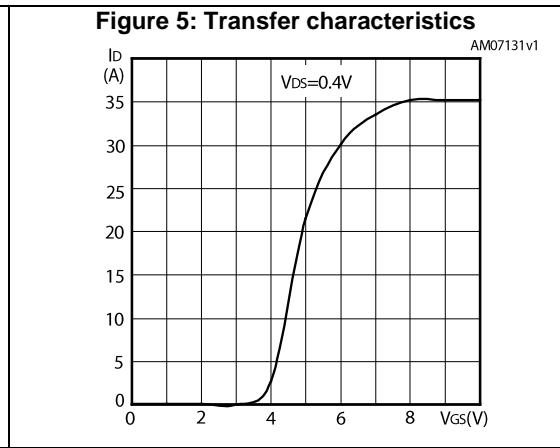
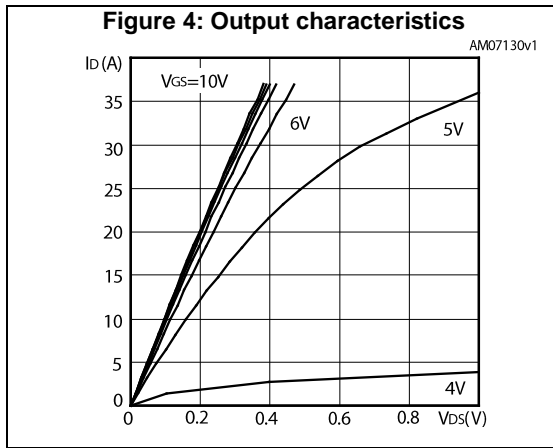
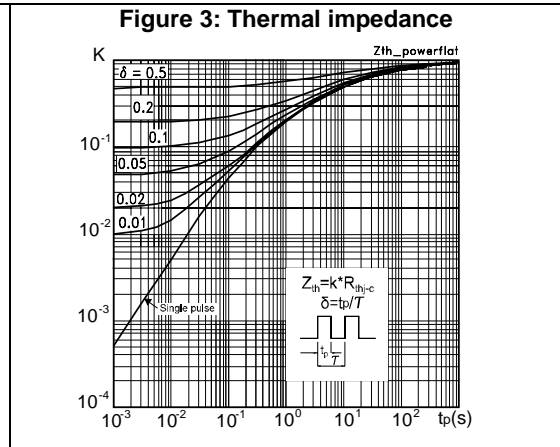
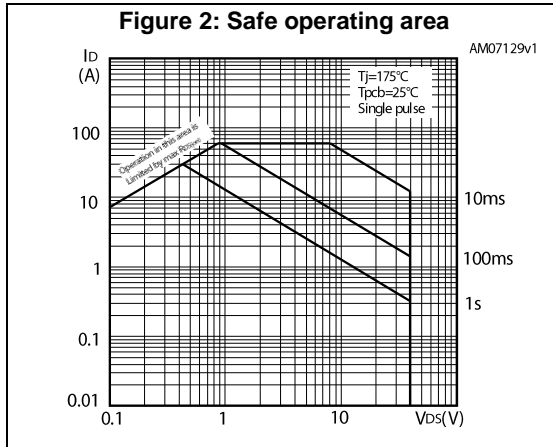

Figure 8: Capacitance variations

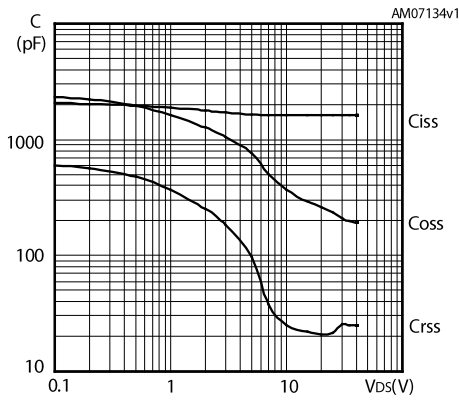

Figure 9: Normalized gate threshold voltage vs temperature

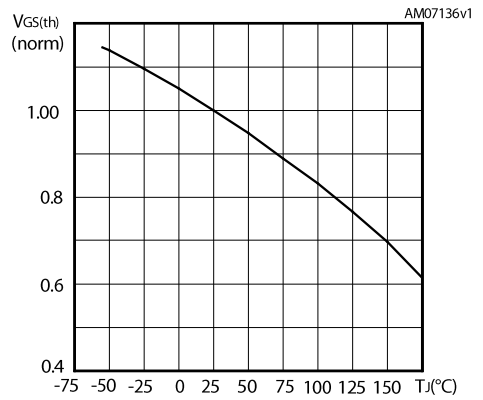

Figure 10: Normalized on-resistance vs temperature

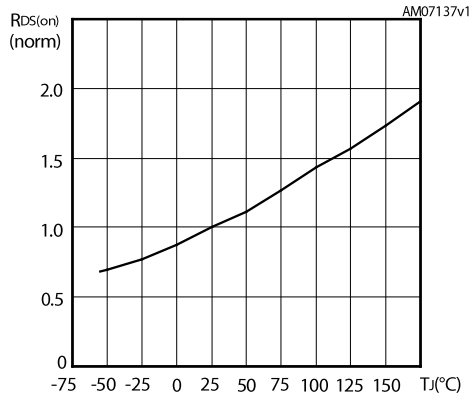

Figure 11: Normalized V_{(BR)DSS} vs temperature

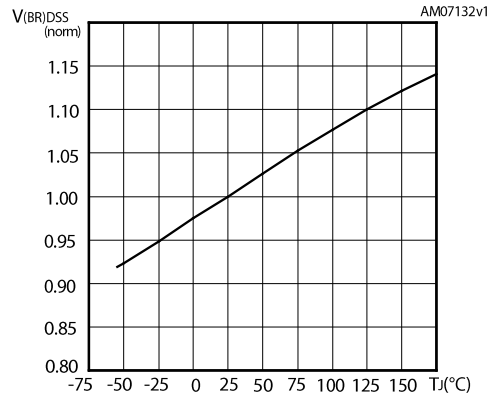
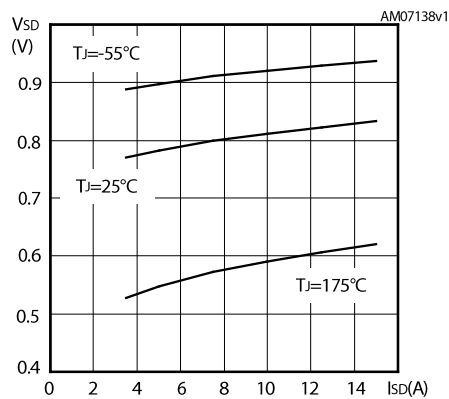

Figure 12: Source-drain diode forward characteristics



3 Test circuits

Figure 13: Test circuit for resistive load switching times



AM01468v1

Figure 14: Test circuit for gate charge behavior



AM01469v1

Figure 15: Test circuit for inductive load switching and diode recovery times

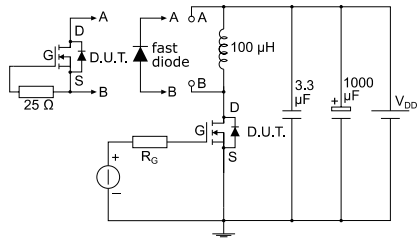

AM01470v1

Figure 16: Unclamped inductive load test circuit

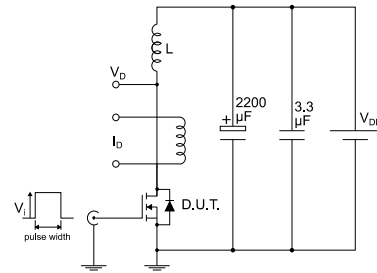

AM01471v1

Figure 17: Unclamped inductive waveform

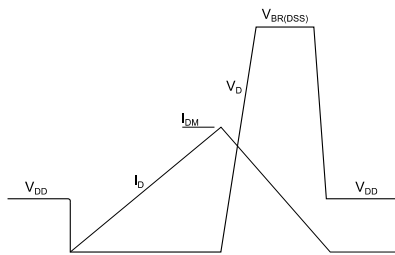

AM01472v1

Figure 18: Switching time waveform

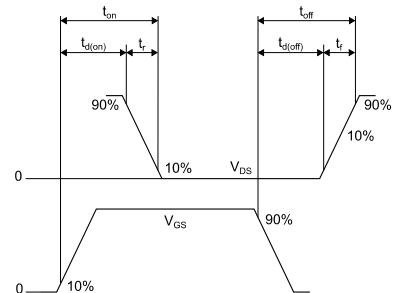

AM01473v1

4 Package information

In order to meet environmental requirements, ST offers these devices in different grades of ECOPACK® packages, depending on their level of environmental compliance. ECOPACK® specifications, grade definitions and product status are available at: www.st.com. ECOPACK® is an ST trademark.

4.1 PowerFLAT 5x6 double island WF type C package information

Figure 19: PowerFLAT™ 5x6 double island WF type C package outline

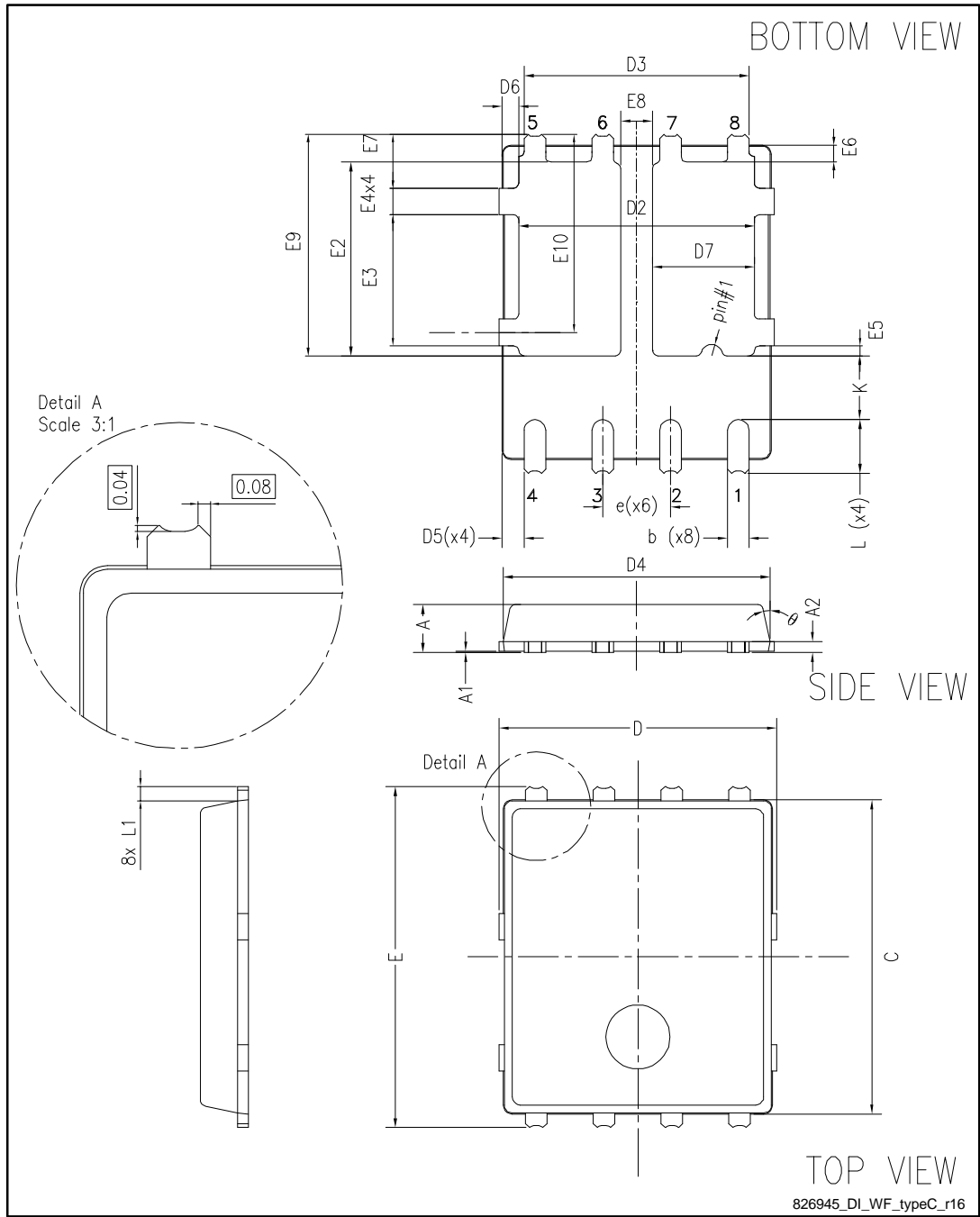
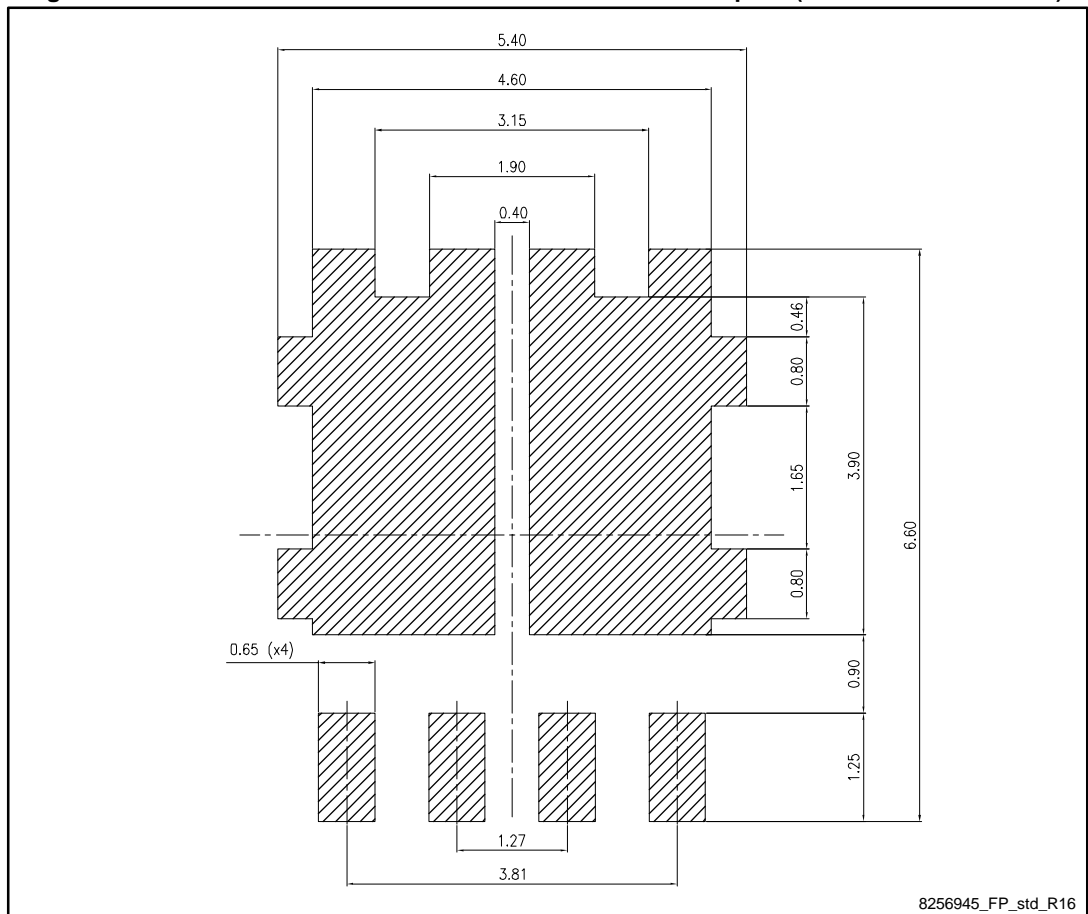

Table 9: PowerFLAT™ 5x6 double island WF type C mechanical data

Dim.	mm		
	Min.	Typ.	Max.
A	0.80		1.00
A1	0.02		0.05
A2		0.25	
b	0.30		0.50
C	5.80	6.00	6.10
D	5.00	5.20	5.40
D2	4.15		4.45
D3	4.05	4.20	4.35
D4	4.80	5.00	5.10
D5	0.25	0.40	0.55
D6	0.15	0.30	0.45
D7	1.68		1.98
e		1.27	
E	6.20	6.40	6.60
E2	3.50		3.70
E3	2.35		2.55
E4	0.40		0.60
E5	0.08		0.28
E6	0.20	0.325	0.45
E7	0.85	1.00	1.15
E8	0.55		0.75
E9	4.00	4.20	4.40
E10	3.55	3.70	3.85
L	0.90	1.00	1.10
L1	0.175	0.275	0.375
K	1.05		1.35
Θ	0°		12°

Figure 20: PowerFLAT™ 5x6 double island recommended footprint (dimensions are in mm)



4.2 Packing information

Figure 21: PowerFLAT™ 5x6 WF tape (dimensions are in mm)

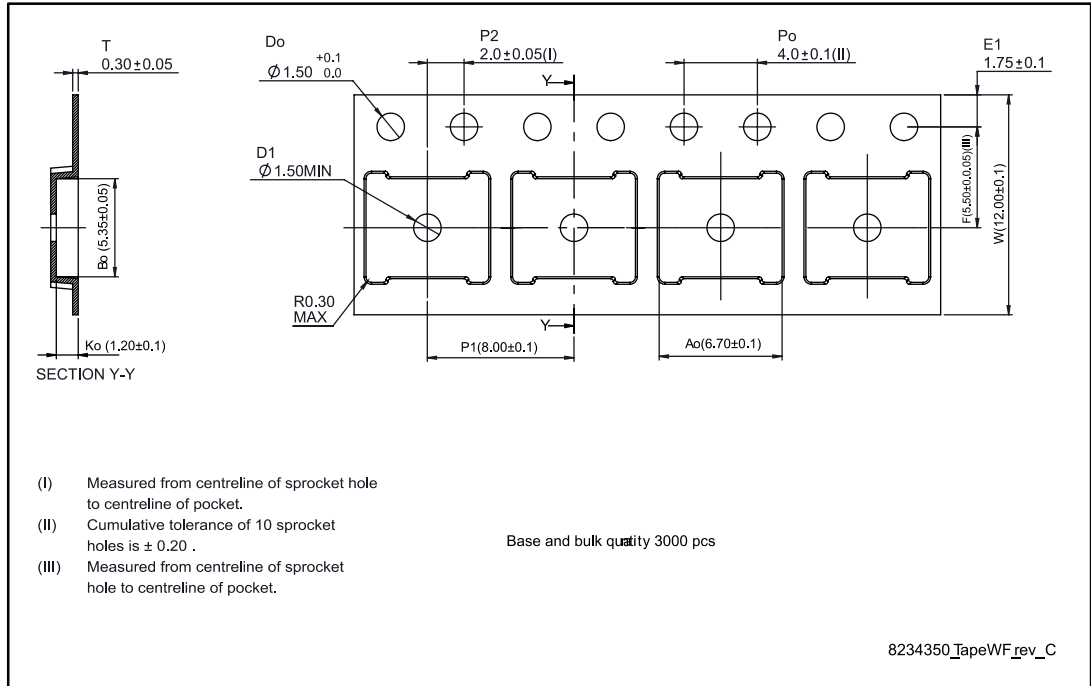

Figure 22: PowerFLAT™ 5x6 package orientation in carrier tape

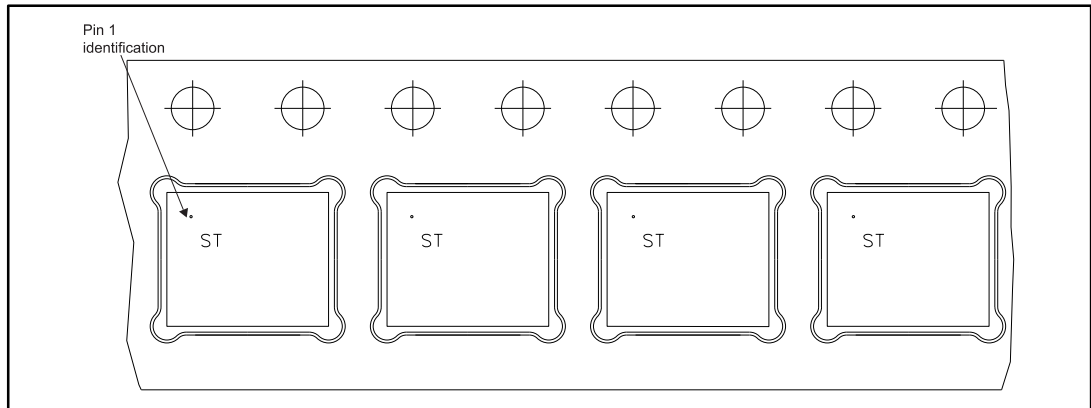
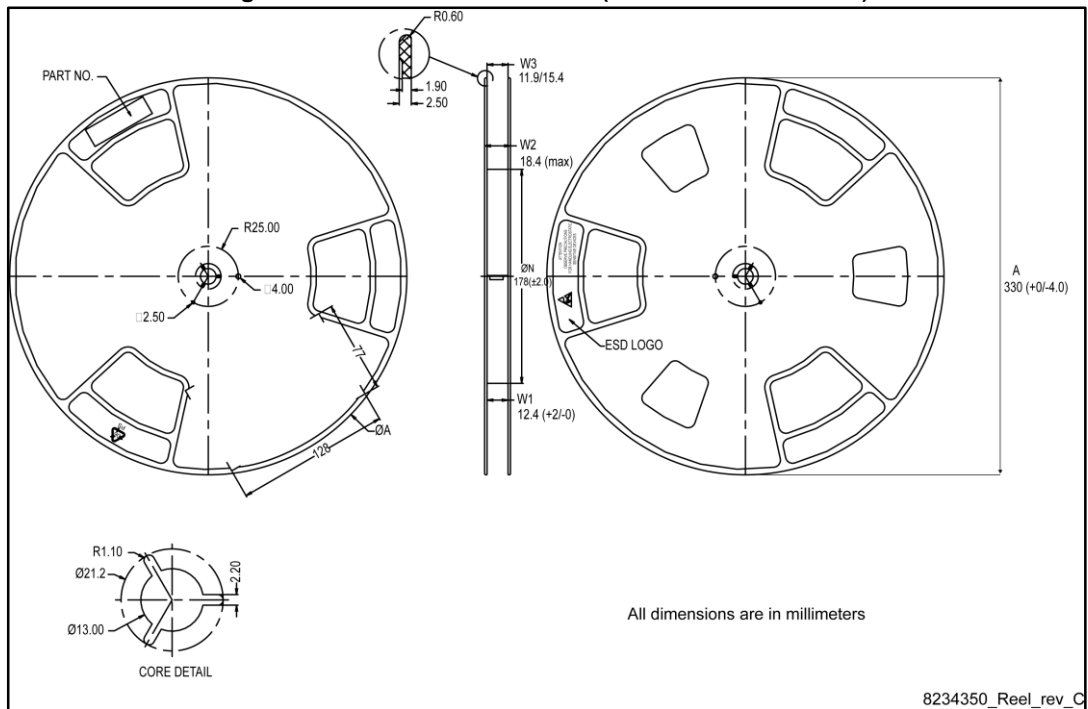

Figure 23: PowerFLAT™ 5x6 reel (dimensions are in mm)



5 Revision history

Table 10: Document revision history

Date	Revision	Changes
02-Sep-2010	1	First release.
01-Jul-2014	2	Updated: <i>Section 4: Package information</i> . Minor text changes
13-Feb-2015	3	Updated <i>Section 4: Package information</i> . Added <i>Section 5: Packaging information</i>
06-Jul-2016	4	Updated: <i>Section 6.1: "PowerFLAT 5x6 double island WF type C package information"</i> . Minor text changes.

IMPORTANT NOTICE – PLEASE READ CAREFULLY

STMicroelectronics NV and its subsidiaries ("ST") reserve the right to make changes, corrections, enhancements, modifications, and improvements to ST products and/or to this document at any time without notice. Purchasers should obtain the latest relevant information on ST products before placing orders. ST products are sold pursuant to ST's terms and conditions of sale in place at the time of order acknowledgement.

Purchasers are solely responsible for the choice, selection, and use of ST products and ST assumes no liability for application assistance or the design of Purchasers' products.

No license, express or implied, to any intellectual property right is granted by ST herein.

Resale of ST products with provisions different from the information set forth herein shall void any warranty granted by ST for such product.

ST and the ST logo are trademarks of ST. All other product or service names are the property of their respective owners.

Information in this document supersedes and replaces information previously supplied in any prior versions of this document.

© 2016 STMicroelectronics – All rights reserved