

Thermally-Enhanced High Power RF LDMOS FETs 180 W, 2110 – 2170 MHz

Description

The PTFB211803EL and PTFB211803FL are 180-watt LDMOS FETs intended for use in multi-standard cellular power amplifier applications in the 2110 to 2170 MHz frequency band. Features include input and output matching, high gain and thermally-enhanced packages with slotted or earless flanges. Manufactured with Infineon's advanced LDMOS process, these devices provide excellent thermal performance and superior reliability.

PTFB211803EL
H-33288-6

PTFB211803FL
H-34288-4/2

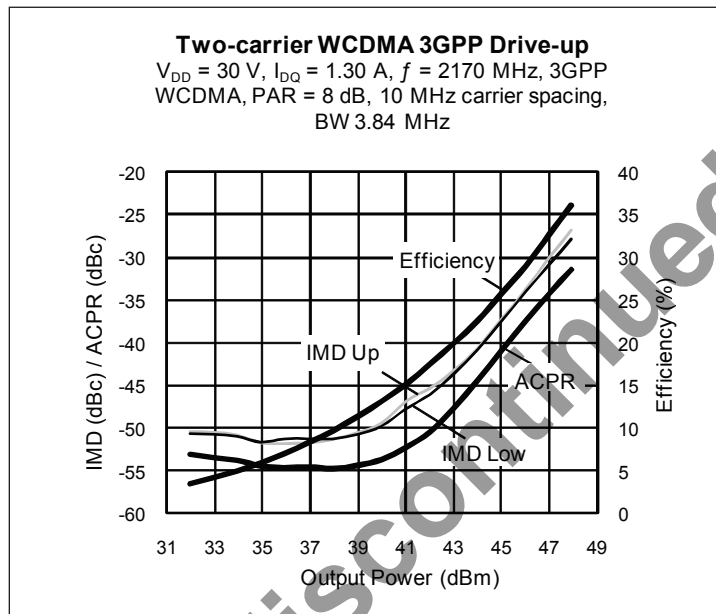

Features

- Broadband internal matching
- Typical two-carrier WCDMA performance at 2170 MHz, 30 V
 - Average output power = 40 W
 - Linear Gain = 17.5 dB
 - Efficiency = 29.7%
 - Intermodulation distortion = -34 dBc
 - Adjacent channel power = -37 dBc
- Typical CW performance, 2170 MHz, 30 V
 - Output power at P_{1dB} = 180 W
 - Efficiency = 55%
- Increased negative gate-source voltage range for improved performance in Doherty amplifiers
- Integrated ESD protection.
- Capable of handling 10:1 VSWR @ 30 V, 180 W (CW) output power
- Pb-free and RoHS compliant

RF Characteristics

Two-carrier WCDMA Measurements (not subject to production test—verified by design/characterization in Infineon test fixture)
 $V_{DD} = 30\text{ V}$, $I_{DQ} = 1.3\text{ A}$, $P_{OUT} = 40\text{ W}$ average, $f_1 = 2135\text{ MHz}$, $f_2 = 2145\text{ MHz}$, 3GPP signal, channel bandwidth = 3.84 MHz, peak/average = 8 dB @ 0.01% CCDF

Characteristic	Symbol	Min	Typ	Max	Unit
Gain	G_{ps}	—	17.5	—	dB
Drain Efficiency	η_D	—	29.5	—	%
Adjacent Channel Power Ratio	ACPR	—	-38	—	dBc

All published data at $T_{CASE} = 25^\circ\text{C}$ unless otherwise indicated

ESD: Electrostatic discharge sensitive device—observe handling precautions!

RF Characteristics (cont.)

Two-carrier WCDMA Measurements (tested in Infineon test fixture)

$V_{DD} = 30\text{ V}$, $I_{DQ} = 1.3\text{ A}$, $P_{OUT} = 38\text{ W}$ average, $f_1 = 2165\text{ MHz}$, $f_2 = 2170\text{ MHz}$, 3GPP signal, channel bandwidth = 3.84 MHz, peak/average = 7.5 dB @ 0.01% CCDF

Characteristic	Symbol	Min	Typ	Max	Unit
Gain	G_{ps}	16	17	—	dB
Drain Efficiency	η_D	28	29.5	—	%
Intermodulation Distortion	IMD	—	-32.5	-31.5	dBc

DC Characteristics

Characteristic	Conditions	Symbol	Min	Typ	Max	Unit
Drain-Source Breakdown Voltage	$V_{GS} = 0\text{ V}$, $I_{DS} = 10\text{ mA}$	$V_{(BR)DSS}$	65	—	—	V
Drain Leakage Current	$V_{DS} = 28\text{ V}$, $V_{GS} = 0\text{ V}$	I_{DSS}	—	—	1.0	μA
Drain Leakage Current	$V_{DS} = 63\text{ V}$, $V_{GS} = 0\text{ V}$	I_{DSS}	—	—	10.0	μA
On-State Resistance	$V_{GS} = 10\text{ V}$, $V_{DS} = 0.1\text{ V}$	$R_{DS(on)}$	—	0.05	—	Ω
Operating Gate Voltage	$V_{DS} = 30\text{ V}$, $I_{DQ} = 1.3\text{ A}$	V_{GS}	2.3	3.0	3.3	V
Gate Leakage Current	$V_{GS} = 10\text{ V}$, $V_{DS} = 0\text{ V}$	I_{GSS}	—	—	1.0	μA

Maximum Ratings

Parameter	Symbol	Value	Unit
Drain-Source Voltage	V_{DSS}	65	V
Gate-Source Voltage	V_{GS}	-6 to +10	V
Junction Temperature	T_J	200	$^{\circ}\text{C}$
Storage Temperature Range	T_{STG}	-40 to +150	$^{\circ}\text{C}$
Thermal Resistance ($T_{CASE} = 70^{\circ}\text{C}$, 180 W CW)	$R_{\theta JC}$	0.3	$^{\circ}\text{C/W}$

Ordering Information

Type and Version	Order Code	Package Description	Shipping
PTFB211803EL V1 R0	PTFB211803ELV1R0XTMA1	H-33288-6, bolt-down	Tape & Reel, 50pcs
PTFB211803EL V1 R250	PTFB211803ELV1R250XTMA1	H-33288-6, bolt-down	Tape & Reel, 250 pcs
PTFB211803FL V2 R0	PTFB211803FLV2R0XTMA1	H-34288-4/2, earless flange	Tape & Reel, 50pcs
PTFB211803FL V2 R250	PTFB211803FLV2R250XTMA1	H-34288-4/2, earless flange	Tape & Reel, 250 pcs

Typical Performance (data taken in a production test fixture)

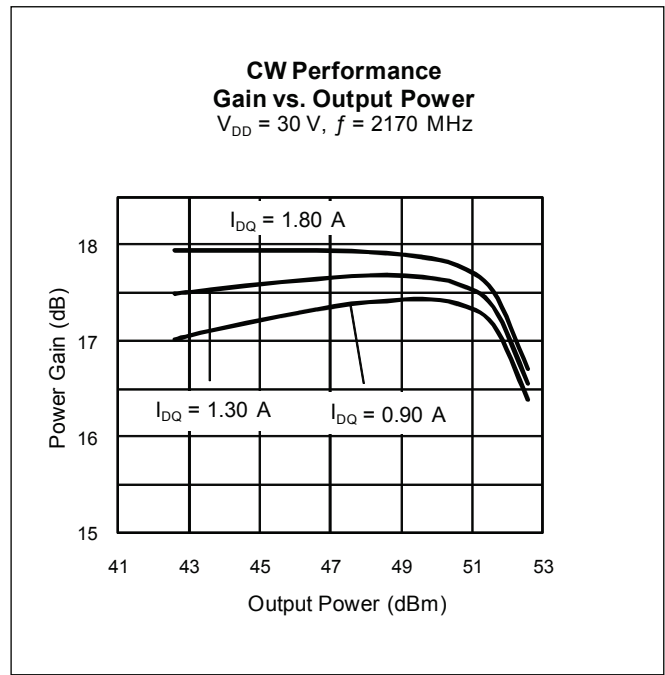
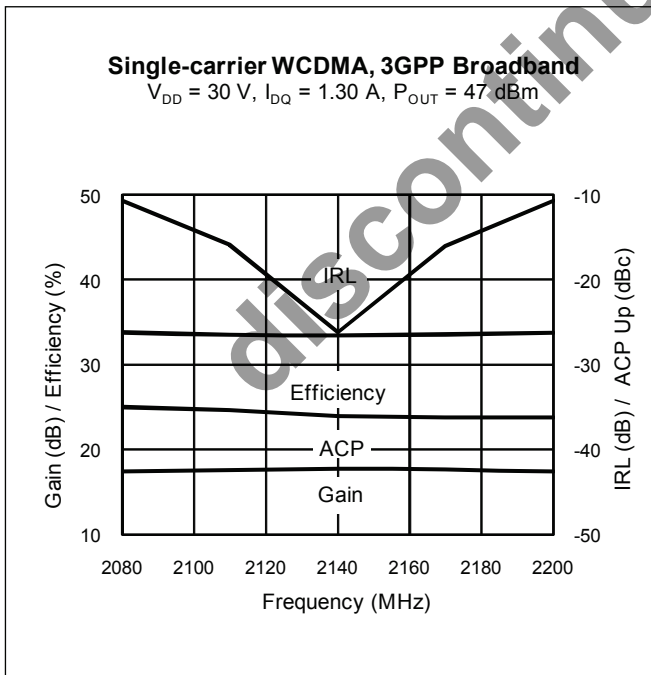
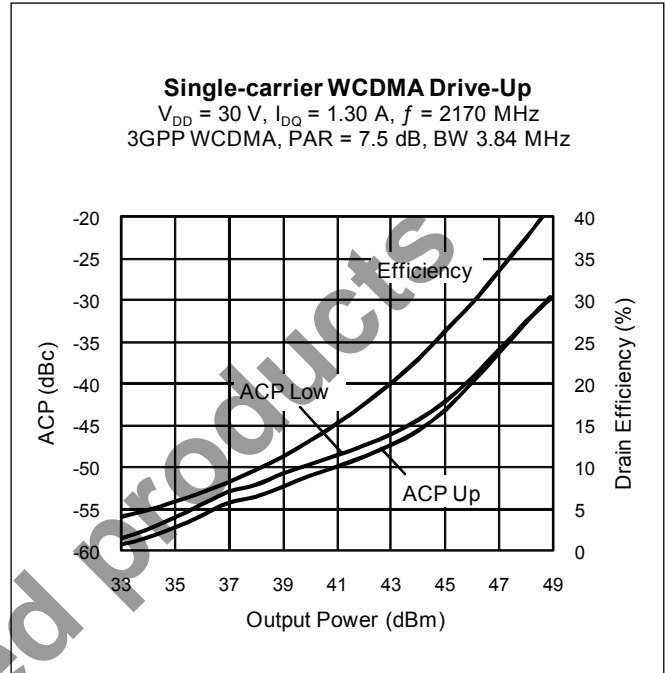
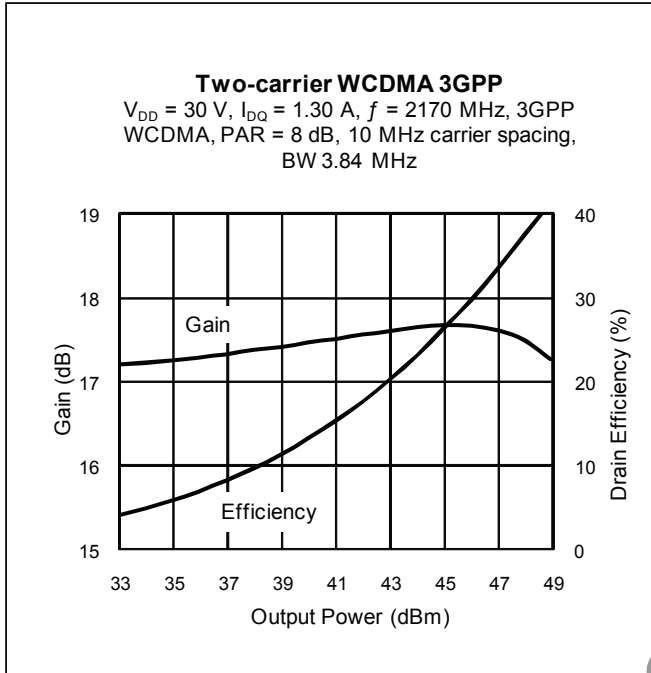

Typical Performance (cont.)

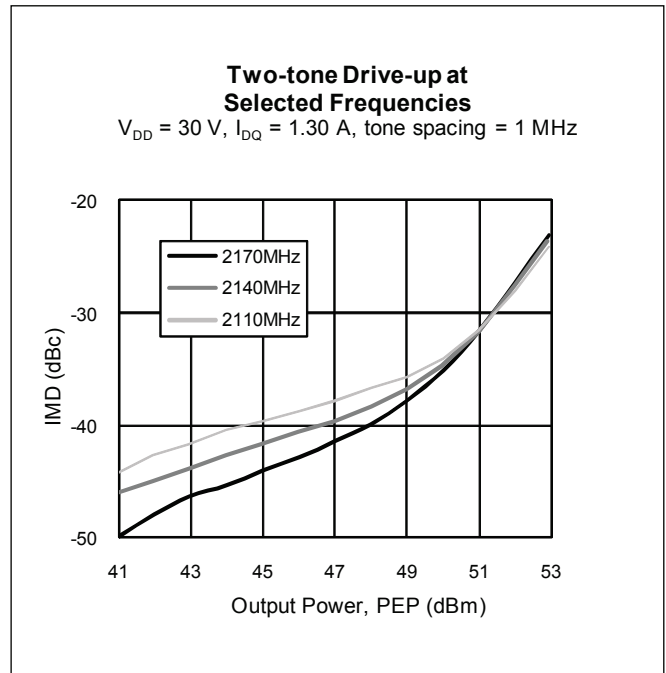
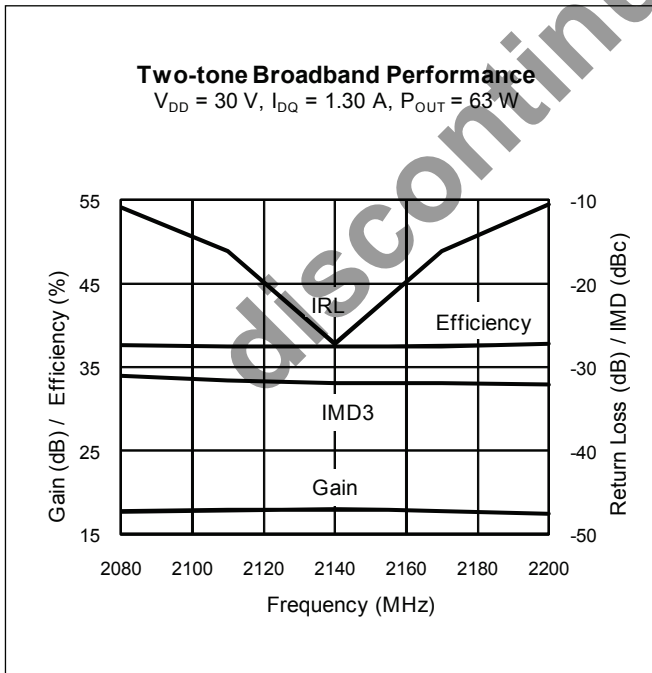
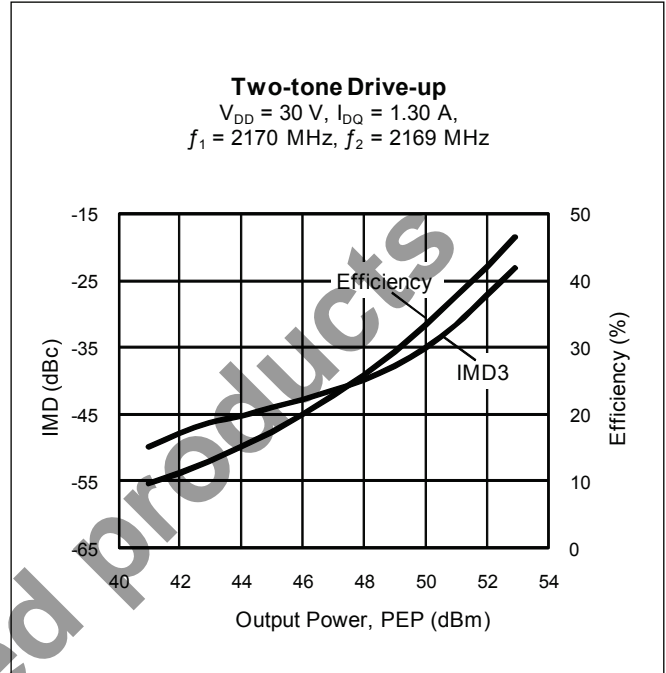
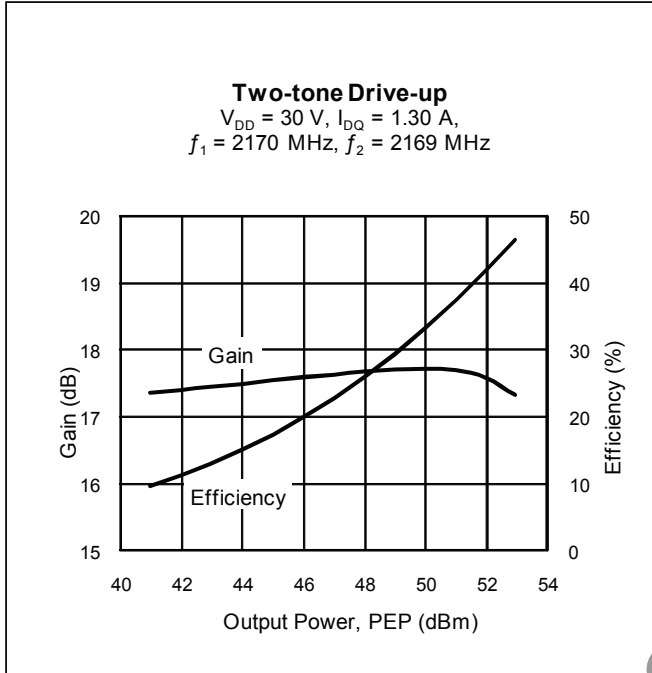

Typical Performance (cont.)

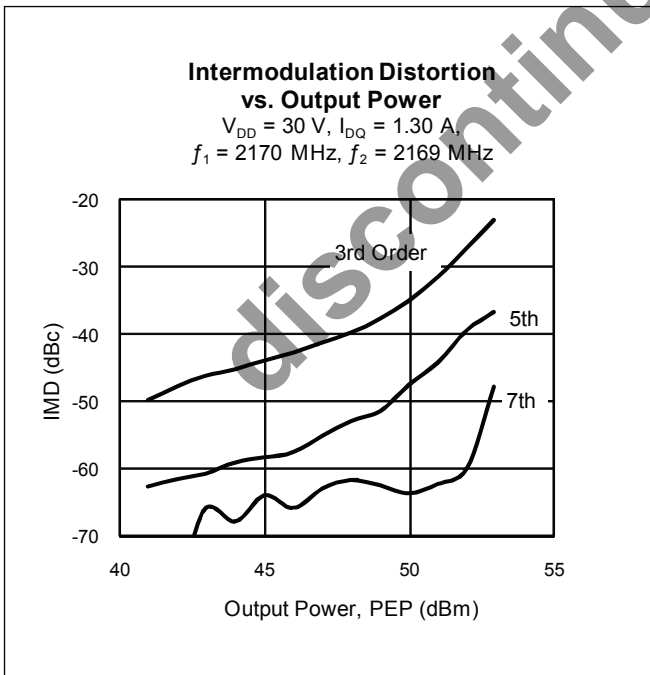
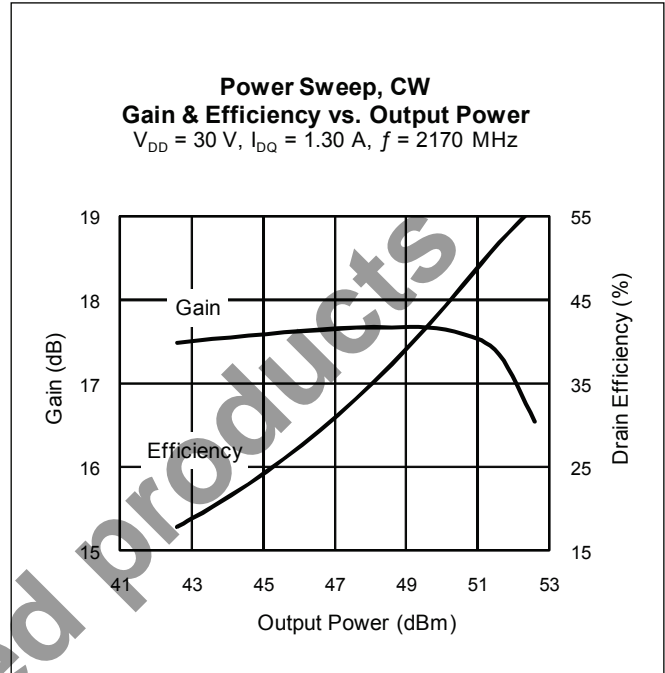
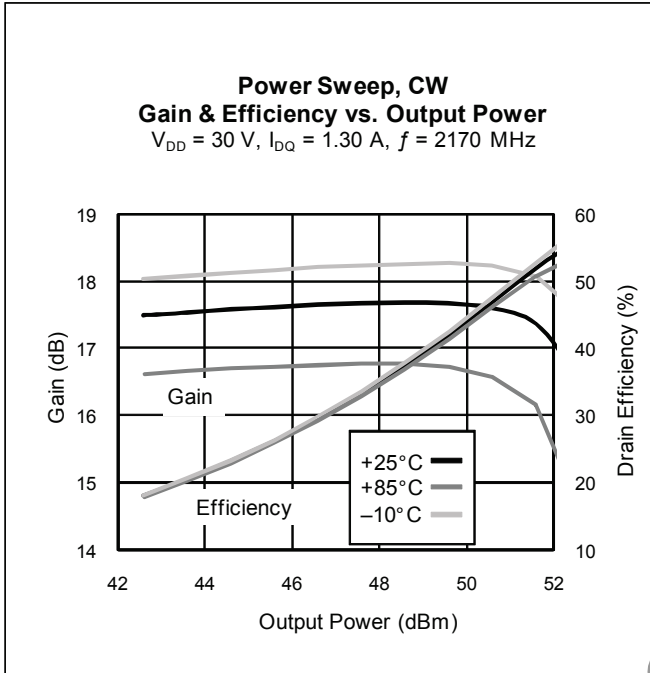

Broadband Circuit Impedance

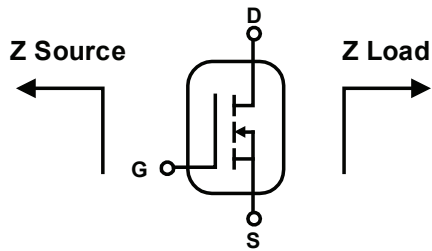

Frequency MHz	Z Source Ω		Z Load Ω	
	R	jX	R	jX
2200	2.02	-6.03	1.70	-4.67
2170	2.12	-6.26	1.72	-4.76
2140	2.23	-6.50	1.73	-4.85
2110	2.34	-6.75	1.75	-4.95
2080	2.47	-7.01	1.77	-5.05

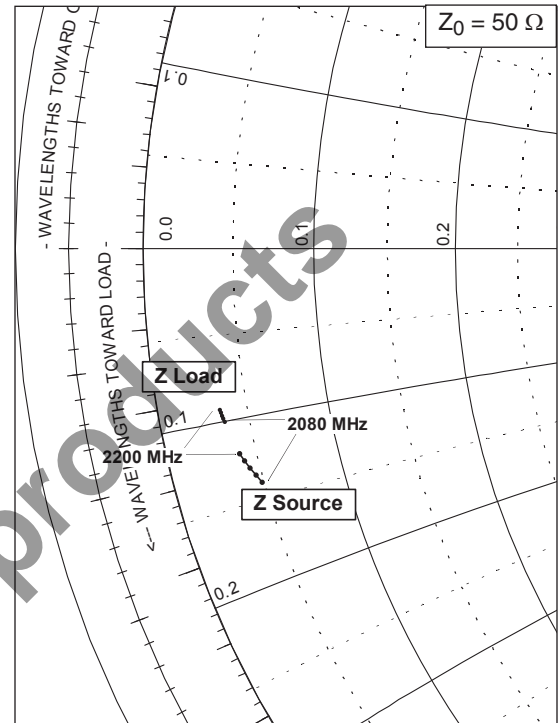

See next page for reference circuit information

discontinued products

Reference Circuit

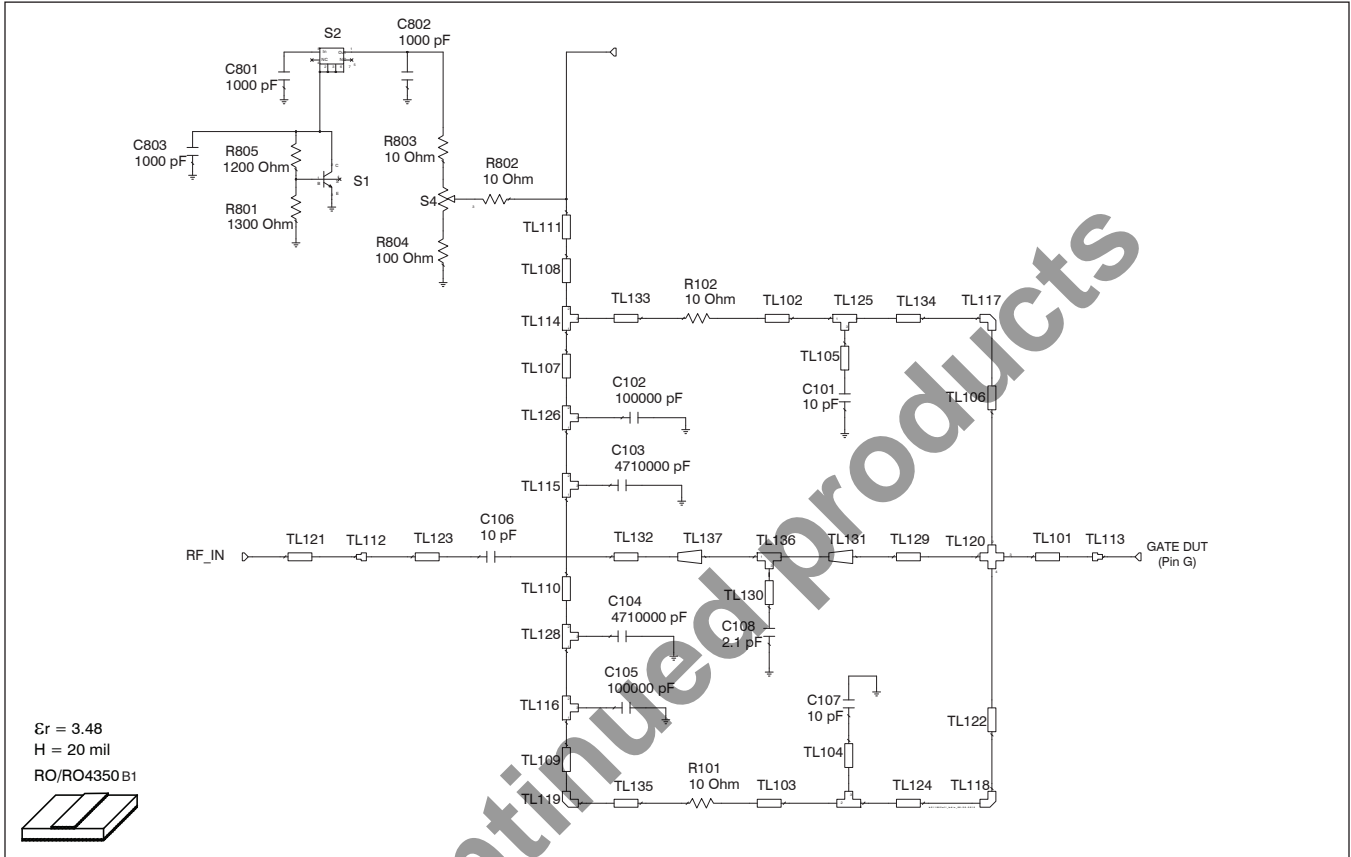

Reference circuit input schematic for $f = 2170 \text{ MHz}$

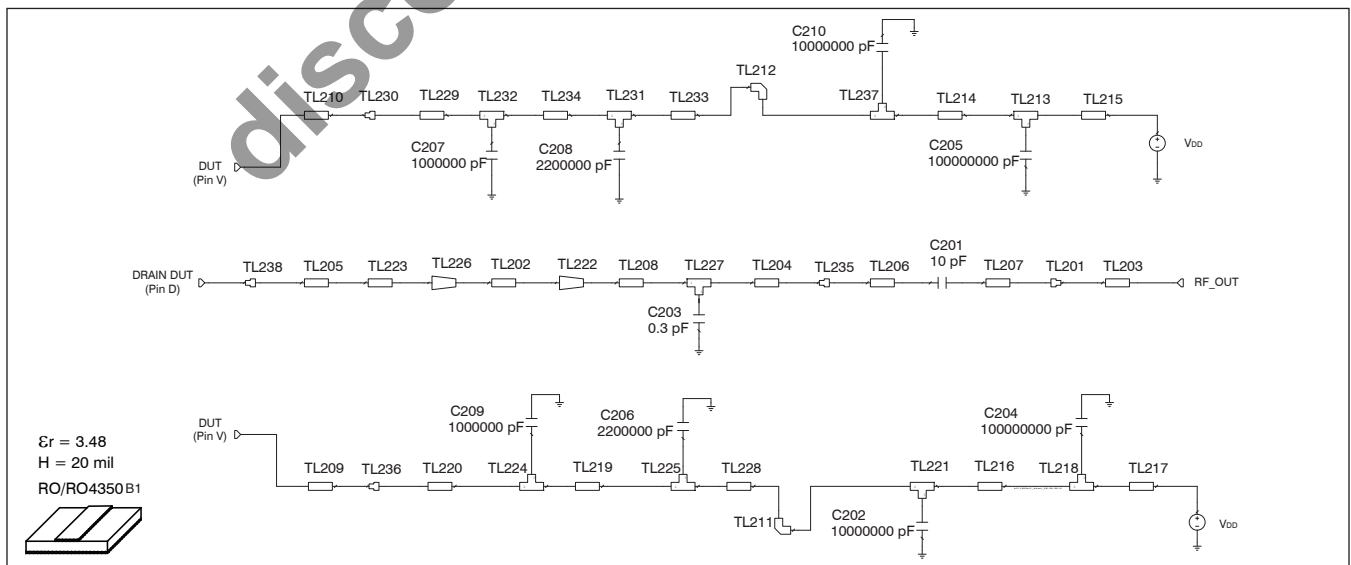

Reference circuit output schematic for $f = 2170 \text{ MHz}$

Reference Circuit (cont.)

Description

DUT	PTFB211803EL or PTFB211803FL
PCB	0.508 mm [.020"] thick, $\epsilon_r = 3.66$, Rogers 4350, 1 oz. copper

Electrical Characteristics at 2170 MHz

Transmission Line	Electrical Characteristics	Dimensions: mm	Dimensions: mils
Input			
TL101	0.053λ , 6.67 Ω	W = 13.970, L = 4.064	W = 550, L = 160
TL102, TL103	0.019λ , 54.17 Ω	W = 1.016, L = 1.575	W = 40, L = 62
TL104, TL105	0.000λ , 36.77 Ω	W = 1.829, L = 0.025	W = 72, L = 1
TL106, TL122	0.026λ , 54.17 Ω	W = 1.016, L = 2.159	W = 40, L = 85
TL107	0.021λ , 54.17 Ω	W = 1.016, L = 1.727	W = 40, L = 68
TL108	0.018λ , 54.17 Ω	W = 1.016, L = 1.524	W = 40, L = 60
TL109	0.029λ , 54.17 Ω	W = 1.016, L = 2.451	W = 40, L = 97
TL110	0.092λ , 63.89 Ω	W = 0.762, L = 7.831	W = 30, L = 308
TL111	0.031λ , 34.72 Ω	W = 1.981, L = 2.540	W = 78, L = 100
TL112		W1 = 1.270, W2 = 2.286	W1 = 50, W2 = 90
TL113		W1 = 17.780, W2 = 12.700	W1 = 700, W2 = 500
TL114	0.012λ , 54.17 Ω	W1 = 1.016, W2 = 1.270, W3 = 1.016	W1 = 40, W2 = 50, W3 = 40
TL115, TL116, TL126, TL128	0.019λ , 63.89 Ω	W1 = 0.762, W2 = 0.762, W3 = 1.600	W1 = 30, W2 = 30, W3 = 63
TL117, TL118, TL119		W = 1.016	W = 40
TL120		W1 = 13.970, W2 = 1.016, W3 = 13.970 W4 = 1.016	W1 = 550, W2 = 40, W3 = 550 W4 = 40
TL121	0.032λ , 47.12 Ω	W = 1.270, L = 2.692	W = 50, L = 106
TL123	0.016λ , 31.24 Ω	W = 2.286, L = 1.270	W = 90, L = 50
TL124, TL134	0.095λ , 54.17 Ω	W = 1.016, L = 8.001	W = 40, L = 315
TL125, TL127	0.022λ , 54.17 Ω	W1 = 1.016, W2 = 1.016, W3 = 1.829	W1 = 40, W2 = 40, W3 = 72
TL129	0.005λ , 6.67 Ω	W = 13.970, L = 0.356	W = 550, L = 14
TL130	0.000λ , 144.35 Ω	W = 0.025, L = 0.025	W = 1, L = 1
TL131 (taper)	0.008λ , 6.67 Ω / 7.64 Ω	W1 = 13.970, W2 = 12.065, L = 0.584	W1 = 550, W2 = 475, L = 23
TL132	0.134λ , 47.12	W = 1.270, L = 11.151	W = 50, L = 439
TL133	0.012λ , 54.17	W = 1.016, L = 1.016	W = 40, L = 40
TL135	0.012λ , 54.17	W = 1.016, L = 1.021	W = 40, L = 40
TL136	0.000λ , 7.64	W1 = 12.065, W2 = 12.065, W3 = 0.025	W1 = 475, W2 = 475, W3 = 1
TL137 (taper)	0.032λ , 7.64 Ω / 47.12 Ω	W1 = 12.065, W2 = 1.270, L = 2.464	W1 = 475, W2 = 50, L = 97

table continued on page 9

Reference Circuit (cont.)

Electrical Characteristics at 2170 MHz

Transmission Line	Electrical Characteristics	Dimensions: mm	Dimensions: mils
Output			
TL201		W1 = 1.270, W2 = 2.540	W1 = 50, W2 = 100
TL202	0.001 λ , 5.33 Ω	W = 17.780, L = 0.076	W = 700, L = 3
TL203	0.047 λ , 47.12 Ω	W = 1.270, L = 3.912	W = 50, L = 154
TL204	0.044 λ , 39.51 Ω	W = 1.651, L = 3.581	W = 65, L = 141
TL205	0.054 λ , 4.84 Ω	W = 19.685, L = 4.064	W = 775, L = 160
TL206, TL207	0.016 λ , 28.85 Ω	W = 2.540, L = 1.270	W = 100, L = 50
TL208	0.012 λ , 39.51 Ω	W = 1.651, L = 1.016	W = 65, L = 40
TL209	0.032 λ , 16.90 Ω	W = 4.928, L = 2.540	W = 194, L = 100
TL210	0.032 λ , 17.05 Ω	W = 4.877, L = 2.540	W = 192, L = 100
TL211, TL212		W = 3.048	W = 120
TL213, TL218	0.038 λ , 25.04 Ω	W1 = 3.048, W2 = 3.048, W3 = 3.048	W1 = 120, W2 = 120, W3 = 120
TL214, TL216	0.135 λ , 25.04 Ω	W = 3.048, L = 10.820	W = 120, L = 426
TL215, TL217	0.046 λ , 25.04 Ω	W = 3.048, L = 3.683	W = 120, L = 145
TL219, TL228, TL233, TL234	0.003 λ , 25.04 Ω	W = 3.048, L = 0.254	W = 120, L = 10
TL220, TL229	0.016 λ , 25.04 Ω	W = 3.048, L = 1.270	W = 120, L = 50
TL221, TL237	0.031 λ , 25.04 Ω	W1 = 3.048, W2 = 3.048, W3 = 2.489	W1 = 120, W2 = 120, W3 = 98
TL222 (taper)	0.074 λ , 5.33 Ω / 39.51 Ω	W1 = 17.780, W2 = 1.651, L = 5.588	W1 = 700, W2 = 65, L = 220
TL223	0.003 λ , 4.84 Ω	W = 19.685, L = 0.254	W = 775, L = 10
TL224, TL225, TL231, TL232	0.022 λ , 25.04 Ω	W1 = 3.048, W2 = 3.048, W3 = 1.778	W1 = 120, W2 = 120, W3 = 70
TL226 (taper)	0.010 λ , 4.84 Ω / 5.33 Ω	W1 = 19.685, W2 = 17.780, L = 0.762	W1 = 775, W2 = 700, L = 30
TL227	0.022 λ , 39.51 Ω	W1 = 1.651, W2 = 1.651, W3 = 1.829	W1 = 65, W2 = 65, W3 = 72
TL230, TL236		W1 = 4.928, W2 = 3.048,	W1 = 194, W2 = 120
TL235		W1 = 1.651, W2 = 2.540	W1 = 65, W2 = 100
TL238		W1 = 12.700, W2 = 17.780	W1 = 500, W2 = 700

Reference Circuit (cont.)

Circuit Assembly Information

Test Fixture Part No. LTN/PTFB211803EF

Find Gerber files for this test fixture on the Infineon Web site at <http://www.infineon.com/rfpower>

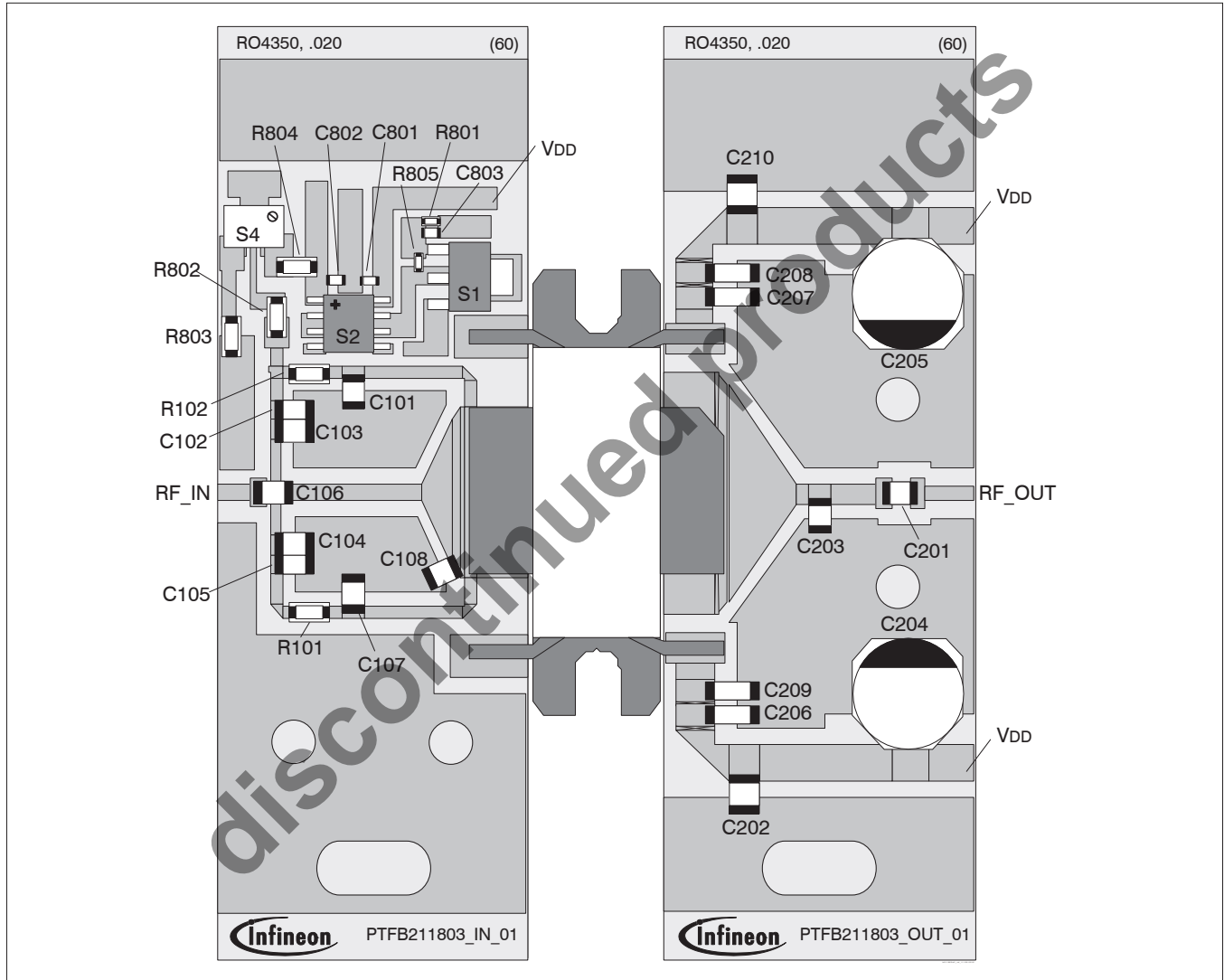

Reference circuit assembly diagram (not to scale)

Reference Circuit (cont.)

Components Information

Component	Description	Suggested Manufacturer	P/N
Input			
C101, C106, C107	Chip capacitor, 10 pF	ATC	ATC100B100JW500XJ
C102, C105	Chip capacitor, 0.1 μ F	Digi-Key	PCC104BCT-ND
C103, C104	Chip capacitor, 4.71 μ F	Digi-Key	493-2372-2-ND
C108	Chip capacitor, 2.1 pF	ATC	ATC100B2R1BW500XB
C801, C802, C803	Capacitor, 1000 pF	Digi-Key	PCC1772CT-ND
R101, R102, R802, R803	Resistor, 10 Ω	Digi-Key	P10ECT-ND
R801	Resistor, 1300 Ω	Digi-Key	P1.3KGCT-ND
R804	Resistor, 100 Ω	Digi-Key	P100ECT-ND
R805	Resistor, 1200 Ω	Digi-Key	P1.2KGCT-ND
S1	Transistor	Digi-Key	BCP56-ND
S2	Voltage Regulator	Digi-Key	LM78L05ACM-ND
S4	Potentiometer, 2k Ω	Digi-Key	3224W-202ECT-ND
Output			
C201	Chip capacitor, 10 pF	ATC	ATC100B100JW500XJ
C202, C210	Capacitor, 10 μ F	Digi-Key	587-1818-2-ND
C203	Chip capacitor, 0.3 pF	ATC	ATC100B0R3BW500XB
C204, C205	Capacitor, 100 μ F	Digi-Key	PCE4442TR-ND
C206, C208	Chip capacitor, 2.2 μ F	Digi-Key	445-1447-2-ND
C207, C209	Chip capacitor, 1 μ F	Digi-Key	445-1411-2-ND

discontinued product

Package Outline Specifications

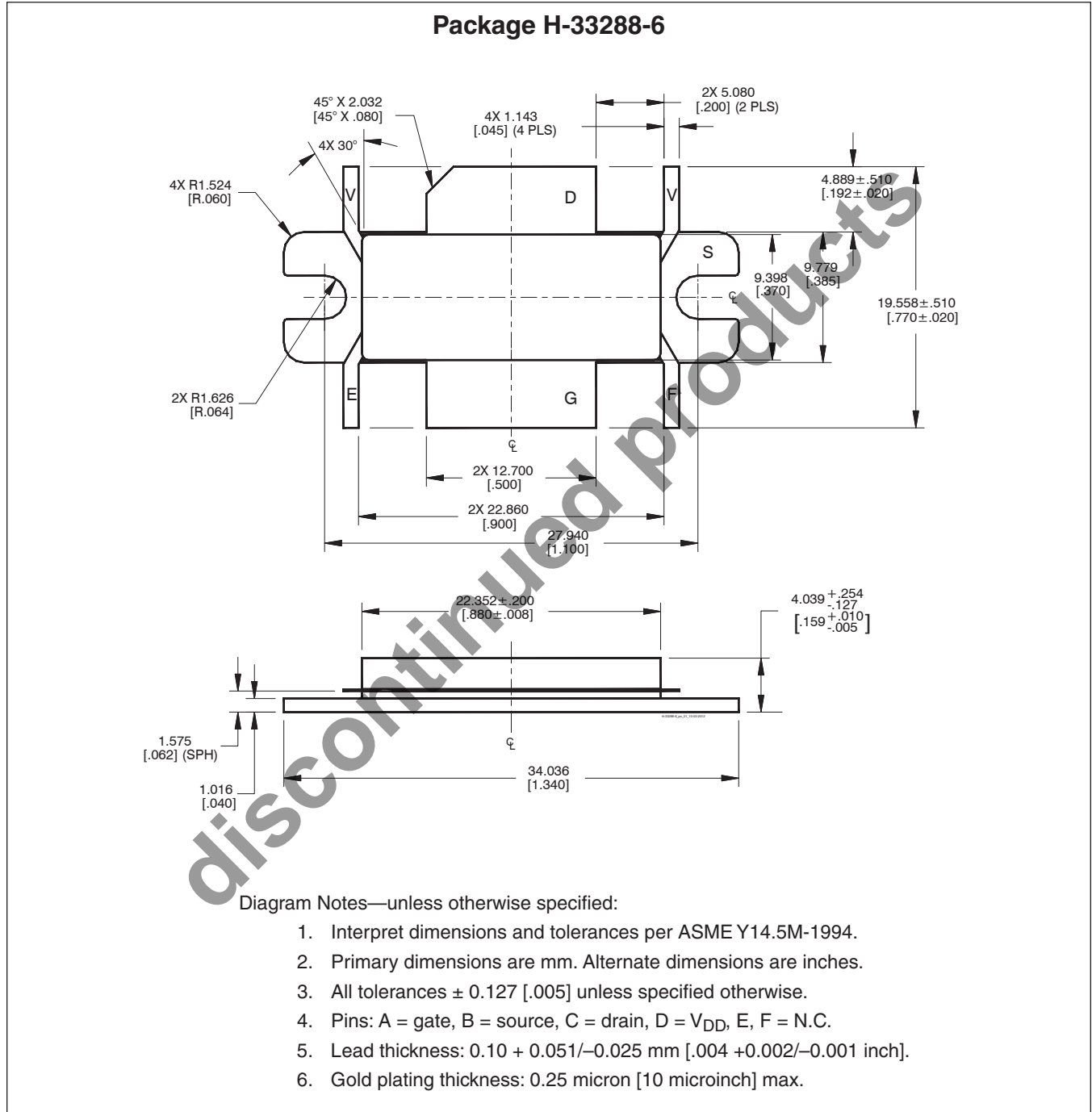

Package Outline Specifications (cont.)

Package H-34288-4/2

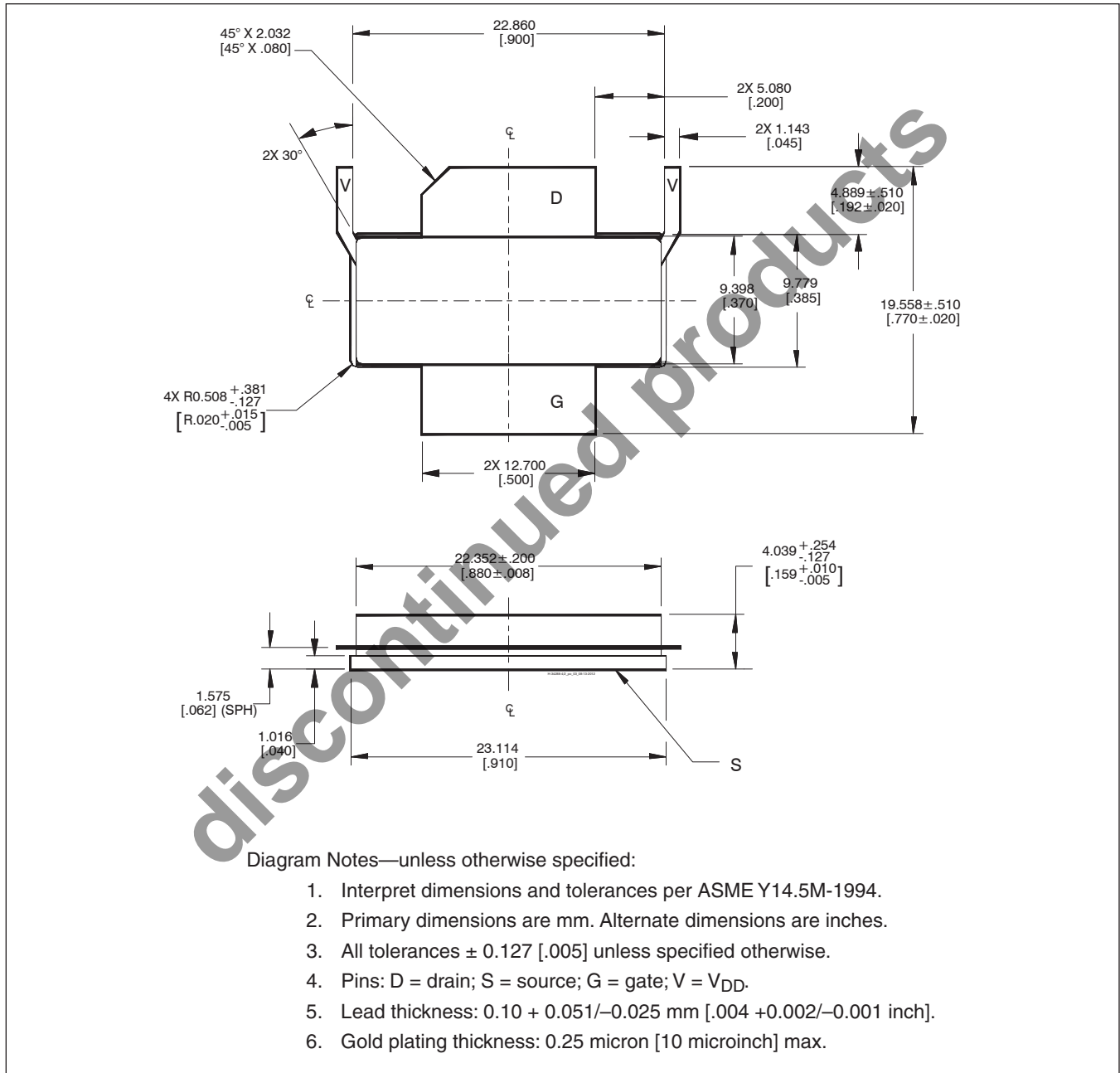

Find the latest and most complete information about products and packaging at the Infineon Internet page <http://www.infineon.com/rfpower>

Page	Subjects (major changes since last revision)
	T[æ ä ã æ] ä \ ^ àæ

We Listen to Your Comments

Any information within this document that you feel is wrong, unclear or missing at all? Your feedback will help us to continuously improve the quality of this document. Please send your proposal (including a reference to this document) to:

highpowerRF@infineon.com

To request other information, contact us at:
 +1 877 465 3667 (1-877-GO-LDMOS) USA
 or +1 408 776 0600 International

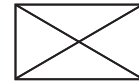

Discontinued products

Edition 20" (†) (†)*

Published by
Infineon Technologies AG
 81726 Munich, Germany

© 2009 Infineon Technologies AG
 All Rights Reserved.

Legal Disclaimer

The information given in this document shall in no event be regarded as a guarantee of conditions or characteristics. With respect to any examples or hints given herein, any typical values stated herein and/or any information regarding the application of the device, Infineon Technologies hereby disclaims any and all warranties and liabilities of any kind, including without limitation, warranties of non-infringement of intellectual property rights of any third party.

Information

For further information on technology, delivery terms and conditions and prices, please contact the nearest Infineon Technologies Office (www.infineon.com/rfpower).

Warnings

Due to technical requirements, components may contain dangerous substances. For information on the types in question, please contact the nearest Infineon Technologies Office.

Infineon Technologies components may be used in life-support devices or systems only with the express written approval of Infineon Technologies, if a failure of such components can reasonably be expected to cause the failure of that life-support device or system or to affect the safety or effectiveness of that device or system. Life support devices or systems are intended to be implanted in the human body or to support and/or maintain and sustain and/or protect human life. If they fail, it is reasonable to assume that the health of the user or other persons may be endangered.