

Glass Passivated Ultrafast Plastic Rectifier



DO-201AD

FEATURES

- Superrectifier structure for high reliability condition
- Cavity-free glass-passivated junction
- Ultrafast reverse recovery time
- Low forward voltage drop
- Low leakage current
- Low switching losses, high efficiency
- High forward surge capability
- Solder dip 275 °C max. 10 s, per JESD 22-B106
- Material categorization: for definitions of compliance please see www.vishay.com/doc?99912



RoHS
COMPLIANT

PRIMARY CHARACTERISTICS	
$I_{F(AV)}$	3.0 A
V_{RRM}	50 V, 100 V, 150 V, 200 V, 300 V, 400 V
I_{FSM}	125 A
t_{rr}	50 ns
V_F	0.95 V, 1.25 V
$T_J \text{ max.}$	175 °C
Package	DO-201AD
Diode variations	Single die

TYPICAL APPLICATIONS

For use in high frequency rectification and freewheeling application in switching mode converters and inverters for consumer, computer, and telecommunication.

MECHANICAL DATA

Case: DO-201AD

Molding compound meets UL 94 V-0 flammability rating
Base P/N-E3 - RoHS-compliant, commercial grade

Terminals: Matte tin plated leads, solderable per J-STD-002 and JESD 22-B102

E3 suffix meets JESD 201 class 1A whisker test

Polarity: Color band denotes cathode end

MAXIMUM RATINGS ($T_A = 25\text{ °C}$ unless otherwise noted)								
PARAMETER	SYMBOL	EGP31A	EGP31B	EGP31C	EGP31D	EGP31F	EGP31G	UNIT
Maximum repetitive peak reverse voltage	V_{RRM}	50	100	150	200	300	400	V
Maximum RMS voltage	V_{RMS}	35	70	105	140	210	280	V
Maximum DC blocking voltage	V_{DC}	50	100	150	200	300	400	V
Maximum average forward rectified current 0.375" (9.5 mm) lead length at $T_L = 150\text{ °C}$	$I_{F(AV)}$	3.0						A
Peak forward surge current 8.3 ms single half sine-wave superimposed on rated load	I_{FSM}	125						A
Operating and storage temperature range	T_J, T_{STG}	-65 to +175						°C



ELECTRICAL CHARACTERISTICS ($T_A = 25\text{ }^\circ\text{C}$ unless otherwise noted)									
PARAMETER	TEST CONDITIONS	SYMBOL	EGP31A	EGP31B	EGP31C	EGP31D	EGP31F	EGP31G	UNIT
Maximum instantaneous forward voltage	3.0 A	V_F (1)	0.95				1.25		V
Maximum DC reverse current at rated DC blocking voltage	$T_A = 25\text{ }^\circ\text{C}$	I_R (2)	5.0						μA
	$T_A = 125\text{ }^\circ\text{C}$		100						
Maximum reverse recovery time	$I_F = 0.5\text{ A}$, $I_R = 1.0\text{ A}$, $t_{rr} = 0.25\text{ A}$	t_{rr}	50						ns
Typical junction capacitance	4.0 V, 1 MHz	C_J	117				48		pF

Notes

- (1) Pulse test: 300 μs pulse width, 1 % duty cycle
- (2) Pulse test: pulse width, $\leq 40\text{ ms}$

THERMAL CHARACTERISTICS ($T_A = 25\text{ }^\circ\text{C}$ unless otherwise noted)									
PARAMETER	SYMBOL	EGP31A	EGP31B	EGP31C	EGP31D	EGP31F	EGP31G	UNIT	
Typical thermal resistance	$R_{\theta JA}$ (1)(2)	55						$^\circ\text{C/W}$	
	$R_{\theta JL}$ (2)(3)	8.5							

Notes

- (1) The heat generated must be less than the thermal conductivity from junction-to-ambient: $dP_D/dT_J < 1/R_{\theta JA}$
- (2) Thermal resistance $R_{\theta JA}$ - junction to ambient, $R_{\theta JL}$ - junction to lead at 0.375" (9.5 mm) lead length (use DC test method)
- (3) Device mounted on 30 mm x 30 mm PCB pad size areas.

ORDERING INFORMATION (Example)				
PREFERRED P/N	UNIT WEIGHT (g)	PREFERRED PACKAGE CODE	BASE QUANTITY	DELIVERY MODE
EGP31G-E3/C	1.21	C	1400	13" diameter paper tape and reel
EGP31G-E3/D	1.21	D	1000	Ammo pack packaging

RATINGS AND CHARACTERISTICS CURVES ($T_A = 25\text{ }^\circ\text{C}$ unless otherwise noted)

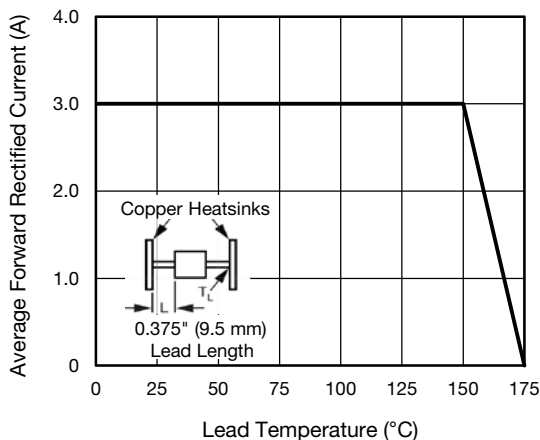

Fig. 1 - Maximum Forward Current Derating Curve

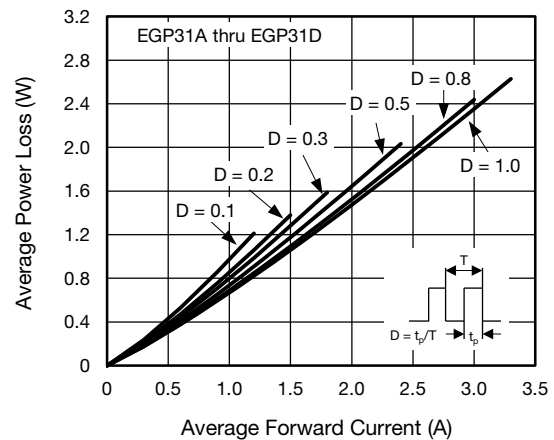

Fig. 2 - Forward Power Loss Characteristics

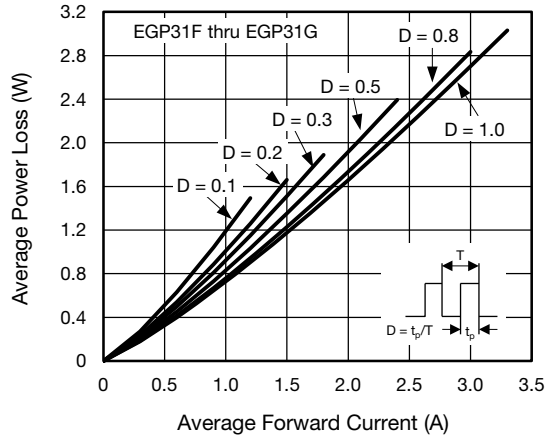

Fig. 3 - Forward Power Loss Characteristics

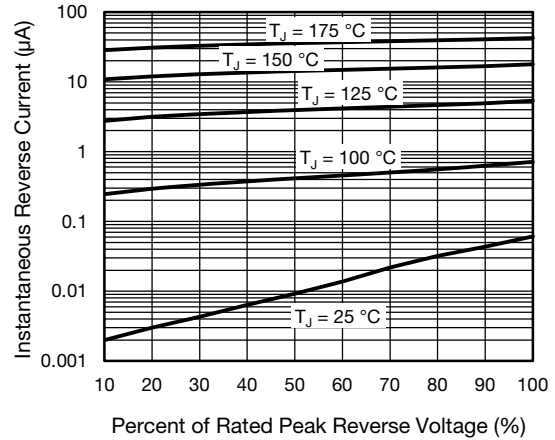

Fig. 6 - Typical Reverse Leakage Characteristics

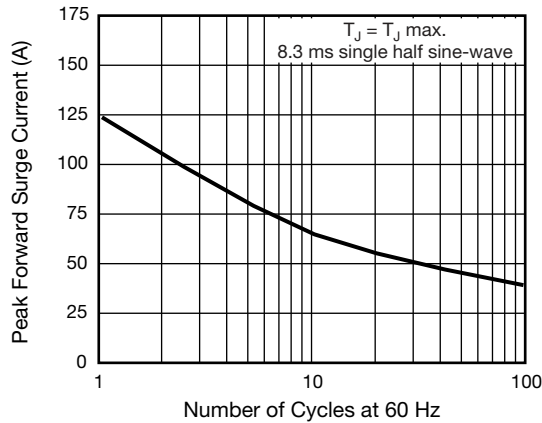

Fig. 4 - Maximum Non-Repetitive Peak Forward Surge Current

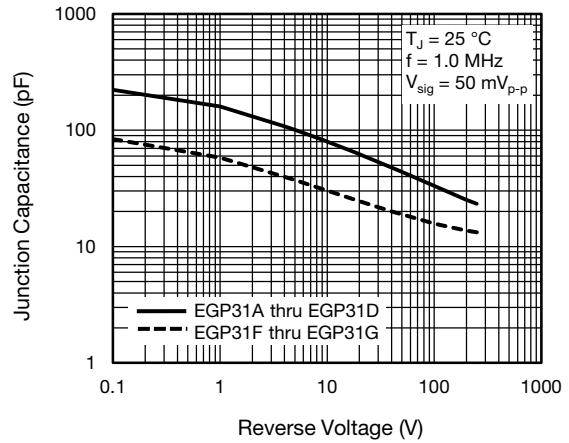

Fig. 7 - Typical Junction Capacitance

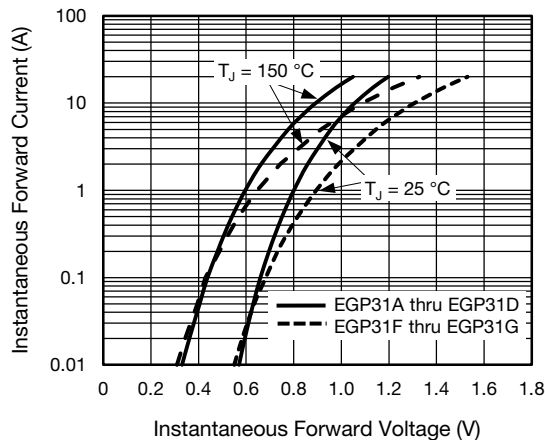

Fig. 5 - Typical Instantaneous Forward Characteristics

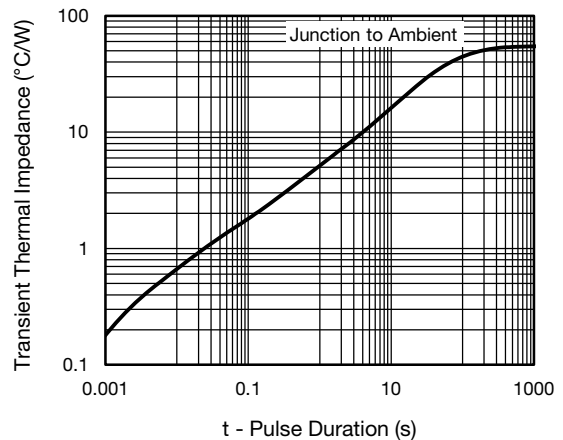
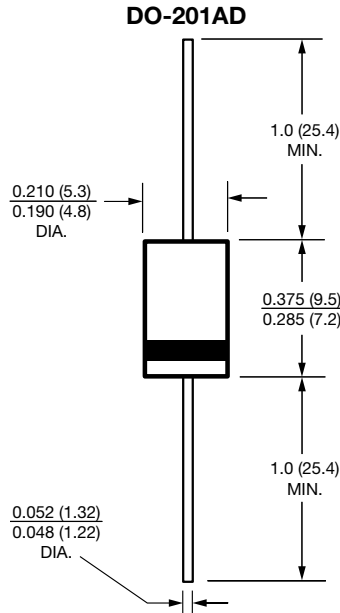

Fig. 8 - Typical Transient Thermal Impedance



PACKAGE OUTLINE DIMENSIONS in inches (millimeters)





Disclaimer

ALL PRODUCT, PRODUCT SPECIFICATIONS AND DATA ARE SUBJECT TO CHANGE WITHOUT NOTICE TO IMPROVE RELIABILITY, FUNCTION OR DESIGN OR OTHERWISE.

Vishay Intertechnology, Inc., its affiliates, agents, and employees, and all persons acting on its or their behalf (collectively, "Vishay"), disclaim any and all liability for any errors, inaccuracies or incompleteness contained in any datasheet or in any other disclosure relating to any product.

Vishay makes no warranty, representation or guarantee regarding the suitability of the products for any particular purpose or the continuing production of any product. To the maximum extent permitted by applicable law, Vishay disclaims (i) any and all liability arising out of the application or use of any product, (ii) any and all liability, including without limitation special, consequential or incidental damages, and (iii) any and all implied warranties, including warranties of fitness for particular purpose, non-infringement and merchantability.

Statements regarding the suitability of products for certain types of applications are based on Vishay's knowledge of typical requirements that are often placed on Vishay products in generic applications. Such statements are not binding statements about the suitability of products for a particular application. It is the customer's responsibility to validate that a particular product with the properties described in the product specification is suitable for use in a particular application. Parameters provided in datasheets and / or specifications may vary in different applications and performance may vary over time. All operating parameters, including typical parameters, must be validated for each customer application by the customer's technical experts. Product specifications do not expand or otherwise modify Vishay's terms and conditions of purchase, including but not limited to the warranty expressed therein.

Except as expressly indicated in writing, Vishay products are not designed for use in medical, life-saving, or life-sustaining applications or for any other application in which the failure of the Vishay product could result in personal injury or death. Customers using or selling Vishay products not expressly indicated for use in such applications do so at their own risk. Please contact authorized Vishay personnel to obtain written terms and conditions regarding products designed for such applications.

No license, express or implied, by estoppel or otherwise, to any intellectual property rights is granted by this document or by any conduct of Vishay. Product names and markings noted herein may be trademarks of their respective owners.