

RECTIFIERS

High Efficiency, 50A and 70A

UES801 BYW78-50
 UES802 BYW78-100
 UES803 BYW78-150

FEATURES

- High Continuous Current Rating
- Very Low Forward Voltage
- Very Fast Switching Speeds
- High Surge Capability
- Low Thermal Resistance
- Mechanically Rugged DO-5 Package

DESCRIPTION

This Series is specifically designed for operation in power switching circuits operating at frequencies of at least 20KHz. The very low forward voltage and very fast recovery time make them particularly suited for switching type power supplies.

ABSOLUTE MAXIMUM RATINGS

	UES801	UES802	UES803	BYW78-50	BYW78-100	BYW78-150
Peak Inverse Voltage, V_R	50V	100V	150V	50V	100V	150V
Repetitive Peak Inverse Voltage, V_{RRM}	50V	100V	150V	50V	100V	150V
Non-Repetitive Peak Inverse Voltage, V_{RSM}	50V	100V	150V	50V	100V	150V
Maximum Average D.C. Output Current, I_o @ $T_c = 100^\circ C$	70A					
Non-Repetitive Sinusoidal Surge Current (8.3ms), I_{FSM}	800A			1500A		
Thermal Resistance, Junction to Case, $R_{\theta JC}$	0.8°C/W					
Storage Temperature Range, T_{STG}	-55°C to +175°C					
Maximum Operating Junction Temperature, $T_{J MAX}$	+175°C					

ELECTRICAL SPECIFICATIONS

Type	Maximum Reverse Voltage V_R	Maximum Forward Voltage V_F		Maximum Reverse Current I_R		Maximum Reverse Recovery Time t_{RR}
		$T_c = 25^\circ C$	$T_c = 150^\circ C$	$T_c = 25^\circ C$	$T_c = 150^\circ C$	
UES801 UES802 UES803	50V 100V 150V	0.9/5V @ $I_F = 70A$	0.84V @ $I_F = 70A$	25 μA @ Rated V_R	30mA @ Rated V_R	50ns ⁽¹⁾
BYW78-50 BYW78-100 BYW78-150	50V 100V 150V	1.1V @ $I_F = 160A$	0.85V @ $I_F = 50A$	50 μA @ Rated V_R	5mA @ Rated V_R	60ns ⁽²⁾

(1) Measured in circuit $I_F = 0.5A$, $I_R = 1A$, $I_{REC} = 0.25A$

(2) Measured in circuit $I_F = 1A$, $V_R = 30V$, $dI_F/dt = 50A/\mu s$

MECHANICAL SPECIFICATIONS

**UES800 SERIES
BYW78 SERIES**

	ins.	mm
A	225 ± .005	5.72 ± 0.13
B	060 MIN.	1.52 MIN.
C	156 ± .020	3.96 ± 0.51
D	156 MIN. FLAT	3.96 MIN. FLAT
E	667 DIA. MAX.	16.94 DIA. MAX.
F	090 MAX.	2.29 MAX.
G	677 ± .010	17.20 ± 0.25
H	375 MAX.	9.43 MAX.
J	140 MIN. DIA.	3.56 MIN. DIA.
K	1.000 MAX.	25.40 MAX.
L	450 MAX.	11.43 MAX.
M	438 ± .015	11.13 ± 0.38
N	078 MAX.	1.98 MAX.

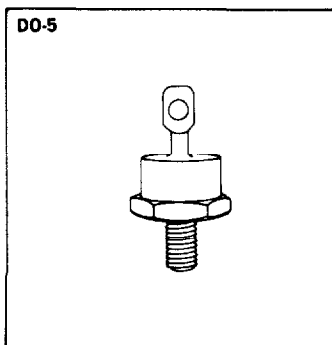

Notes:

1. Standard polarity is cathode-to-stud
2. All metal surfaces tin plated.
3. Maximum unlubricated stud torque: 20 inch pounds (20 kg. cm).
4. Angular orientation of terminal is undefined.

Microsemi Corp.
Watertown
 The diode experts

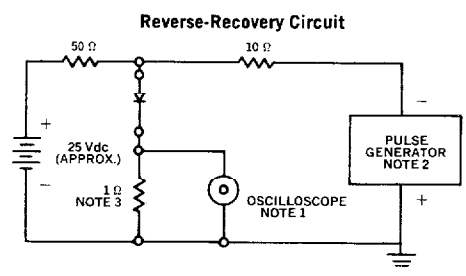
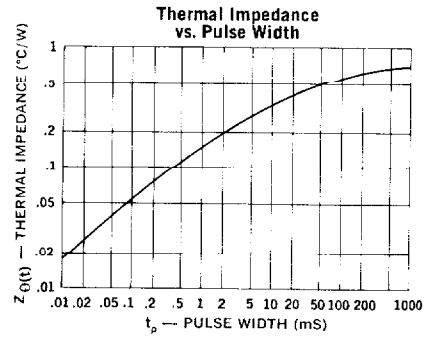
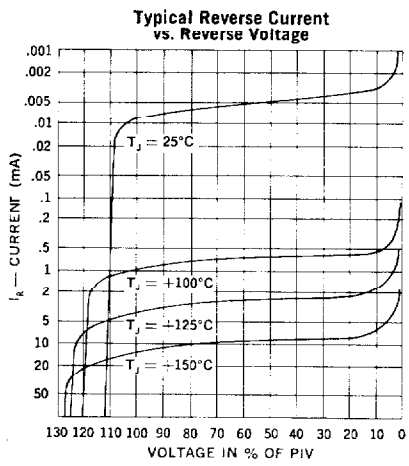
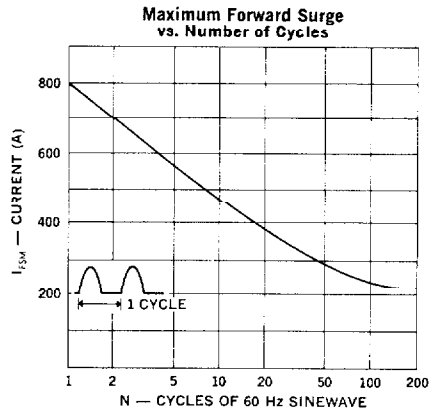
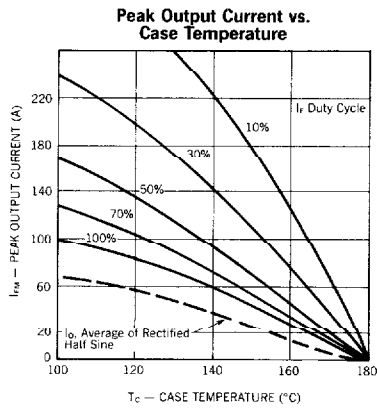
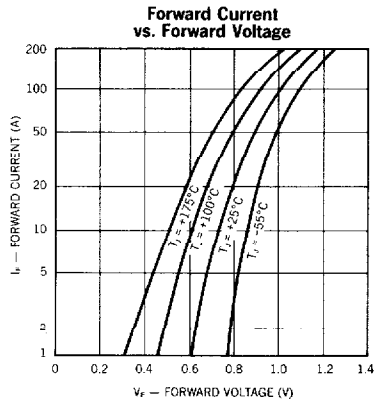
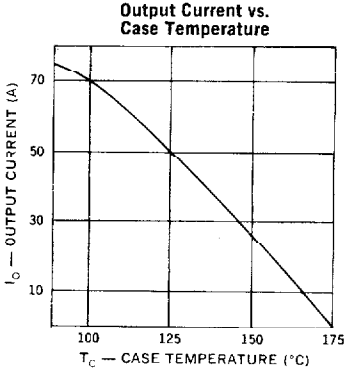

- NOTES:**
- Oscilloscope: Rise time ≤ 3 ns; input impedance = 50 Ω .
 - Pulse Generator: Rise time ≤ 8 ns; source impedance 10 Ω .
 - Current viewing resistor, non-inductive, coaxial recommended.