



# Aluminum electrolytic capacitors

Axial-lead and soldering star capacitors

**Series/Type:** B41690, B41790

**Date:** December 2016

© EPCOS AG 2016. Reproduction, publication and dissemination of this publication, enclosures hereto and the information contained therein without EPCOS' prior express consent is prohibited.

EPCOS AG is a TDK Group Company.

### Applications

- Automotive electronics

### Features

- High vibration stability, special design with high vibration stability up to 60 g available upon request
- Ultra compact design
- Long useful life, 2000 h at up to 140 °C
- High ripple current capability
- SIKOREL design – storage for up to 15 years at a temperature of up to 35 °C
- RoHS-compatible

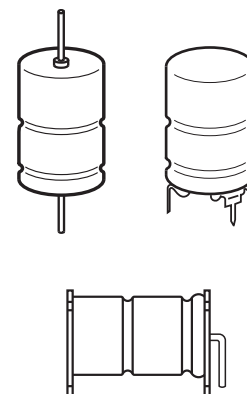

### Construction

- Charge/discharge-proof, polar
- Aluminum case with insulating sleeve
- Negative pole connected to case
- Version without insulation available upon request

### Terminals

- Axial leads, welded to capacitor case and cover disc
- Soldering star option for upright mounting on PCB
- Alternative axial-lead design with double-sided plates for horizontal mounting available upon request

### Taping and packing

- Axial-lead capacitors will be delivered in pallet package  
Capacitors with  $d \times l \leq 16 \times 30$  mm are also available taped on reel
- Soldering star capacitors are packed in blister trays

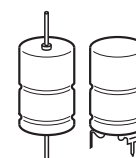

**Specifications and characteristics in brief**

Rated voltage $V_R$	25 ... 40 V DC							
Surge voltage $V_S$	$1.3 \cdot V_R$							
Rated capacitance $C_R$	600 ... 10000 $\mu\text{F}$							
Capacitance tolerance	$-10/+30\% \triangle Q$							
Leakage current $I_{\text{leak}}$ (5 min, 20 °C)	$I_{\text{leak}} \leq 0.006 \mu\text{A} \cdot \left( \frac{C_R}{\mu\text{F}} \cdot \frac{V_R}{\text{V}} \right) + 4 \mu\text{A}$							
Self-inductance ESL <sup>1)</sup>	Diameter d (mm)	12	14	16	18	20	21	
	Terminals	Length l (mm)						Approx. ESL (nH)
	axial	25	–	22	26	30	–	–
		29	–	–	–	–	38	–
		30	21	24	29	34	–	–
		35	–	–	31	–	–	–
		39	–	–	33	38	–	45
	soldering star	49	–	–	–	–	–	50
		25	–	6	7	8	–	–
		30	6	7	8	10	–	–
		35	–	–	9	–	–	–
39		–	–	9	11	–	13	
49	–	–	–	–	–	–	14	
Useful life <sup>2)</sup> 140 °C; $V_R$ ; $0.6 \cdot I_{AC,R}$ 125 °C; $V_R$ ; $I_{AC,R}$ 85 °C; $V_R$ ; $I_{AC,max}$ 40 °C; $V_R$ ; $2 \cdot I_{AC,R}$	> 2000 h	Requirements:						
	> 5000 h	$ \Delta C/C  \leq 30\%$ of initial value						
	> 15000 h	ESR $\leq 3$ times initial specified limit <sup>3)</sup>						
	> 500000 h	$I_{\text{leak}} \leq$ initial specified limit						
Voltage endurance test 125 °C; $V_R$	2000 h	Post test requirements:						
		$ \Delta C/C  \leq 10\%$ of initial value						
		ESR $\leq 1.3$ times initial specified limit <sup>3)</sup>						
Vibration resistance test	To IEC 60068-2-6, test Fc: Frequency range 10 Hz ... 2 kHz, displacement amplitude max. 1.5 mm, acceleration max. 20 g, duration $3 \times 2$ h. Capacitor mounted by its wire leads at a distance of $(6 \pm 1)$ mm from the case and additionally clamped by the case.							
	IEC climatic category							
	To IEC 60068-1: 55/125/56 (–55 °C/+125 °C/56 days damp heat test)							
Detail specification	Similar to CECC 30301-802							
Sectional specification	IEC 60384-4							

1) If optimum circuit design is used, the values are lower by 30%.

2) Refer to chapter "General technical information, 5 Useful life" on how to interpret useful life.

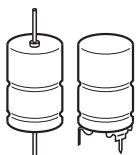
3)  $ESR_{\text{max}}$  at 100 Hz, 20 °C



**B41690, B41790**

**Ultra compact – up to 140 °C**

**B41690, Axial-lead capacitors**

**Dimensional drawing**

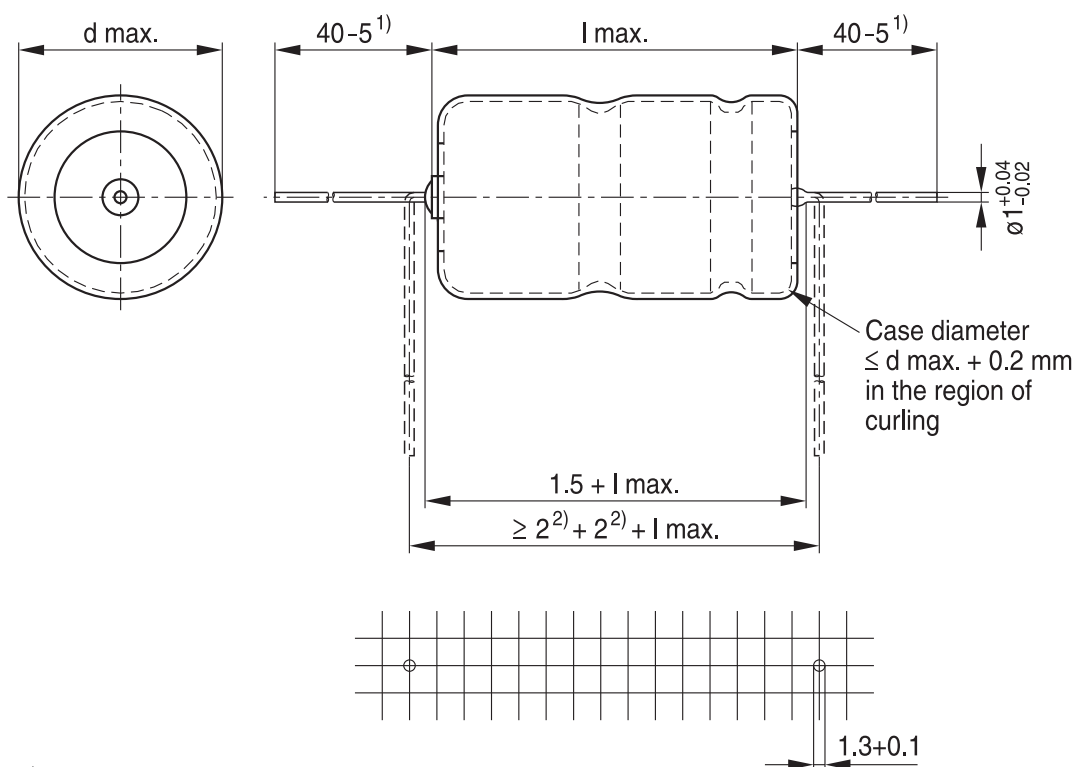

1) For  $d = 21 \text{ mm}$ : 35-5

2) Minimum 2 mm bending distance per wire recommended

KAL1655-Y-E

**Dimensions, weights and packing units**

$d \times l$ mm	$d_{\max} \times l_{\max}$ mm	Approx. weight g	Packing units (pcs.)	
			Pallet	Reel
12 × 30	12.5 × 30.5	5.1	288	450
14 × 25	14.5 × 25.5	5.7	200	350
14 × 30	14.5 × 30.5	6.8	200	350
16 × 25	16.5 × 25.5	7.4	180	250
16 × 30	16.5 × 30.5	8.9	180	250
16 × 35	16.5 × 35.5	10.4	180	250
16 × 39	16.5 × 40	11.7	180	250
18 × 25	18.5 × 25.5	9.3	160	—
18 × 30	18.5 × 30.5	11.1	160	—
18 × 39	18.5 × 40	14.7	160	—
20 × 29	20.5 × 29.5	13.5	140	—
21 × 39	21.5 × 40	20.0	140	—
21 × 49	21.5 × 50	25.0	110	—

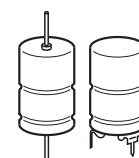
**B41790, Soldering star capacitors**
**Dimensional drawings**

 Mounting holes  $d = 12 \text{ mm} \dots 14 \text{ mm}$ 

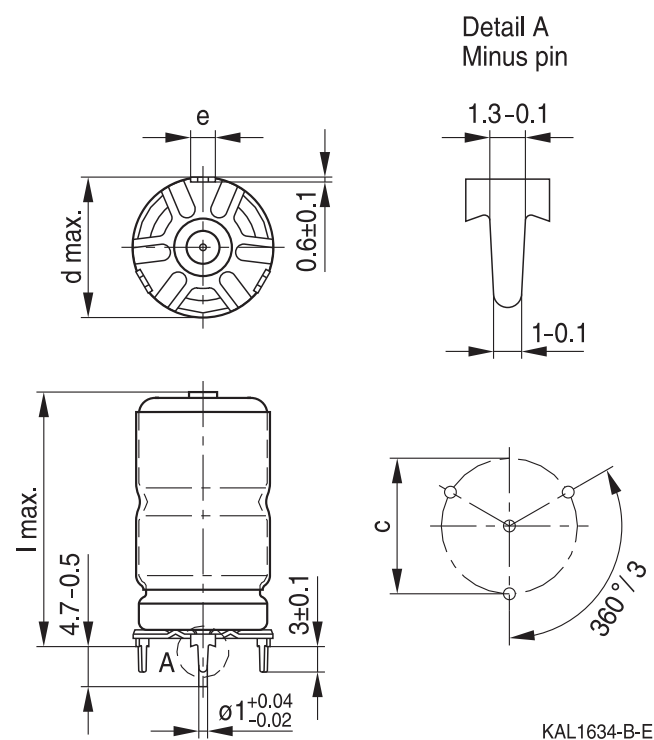
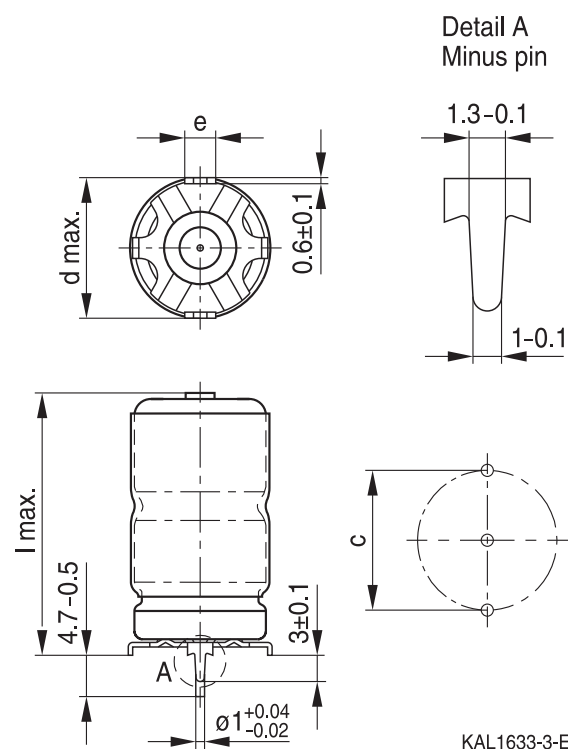
 Mounting holes  $d = 16 \text{ mm} \dots 21 \text{ mm}$ 

**Dimensions, weights and packing units**

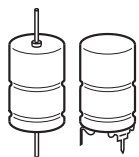
$d \times l$ mm	$d_{\max} \times l_{\max}$ mm	$c \pm 0.1$ mm	$e \pm 0.1$ mm	Approx. weight g	Packing units pcs.
12 × 30	13.5 × 32	12.5	3.0	5.4	480
14 × 25	15.5 × 27	14.5	3.0	6.1	480
14 × 30	15.5 × 32	14.5	3.0	7.2	480
16 × 25	17.5 × 27	16.5	3.0	7.9	300
16 × 30	17.5 × 32	16.5	3.0	9.4	300
16 × 35	17.5 × 37	16.5	3.0	10.9	200
16 × 39	17.5 × 41.5	16.5	3.0	12.2	200
18 × 25	19.5 × 27	18.5	3.0	9.9	300
18 × 30	19.5 × 32	18.5	3.0	11.8	300
18 × 39	19.5 × 41.5	18.5	3.0	15.4	200
21 × 39	22.5 × 41.5	21.5	3.5	21.0	324
21 × 49	22.5 × 51.5	21.5	3.5	26.0	264



**B41690, B41790**

**Ultra compact – up to 140 °C**

### Overview of available types

$V_R$ (V DC)	25	35	40
	Case dimensions $d \times l$ (mm)		
$C_R$ ( $\mu\text{F}$ )			
600			12 × 30
1000		14 × 25	14 × 30
1200	12 × 30		
1400		16 × 25	16 × 30
1800			18 × 30
1900		16 × 30	
2000	14 × 30		
2300		16 × 35	20 × 29
2500		18 × 30	
2700			18 × 39
2900	16 × 30		
3000	18 × 25	20 × 29	
3800		18 × 39	
3900	18 × 30		21 × 39
4300	16 × 39		
5000	20 × 29		
5200		21 × 39	21 × 49
5800	18 × 39		
7000		21 × 49	
8000	21 × 39		
10000	21 × 49		

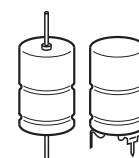

**Case dimensions and ordering codes**

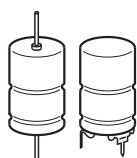
$C_R$ 100 Hz 20 °C $\mu\text{F}$	Case dimensions $d \times l$ mm	Ordering code Axial pallet	Ordering code Axial reel	Ordering code Soldering star
<b><math>V_R = 25 \text{ V DC}</math></b>				
1200	12 × 30	B41690A5128Q001	B41690A5128Q003	B41790A5128Q001
2000	14 × 30	B41690A5208Q001	B41690A5208Q003	B41790A5208Q001
2900	16 × 30	B41690A5298Q001	B41690A5298Q003	B41790A5298Q001
3000	18 × 25	B41690A5308Q001		B41790A5308Q001
3900	18 × 30	B41690A5398Q001		B41790A5398Q001
4300	16 × 39	B41690A5438Q001	B41690A5438Q003	B41790A5438Q001
5000	20 × 29	B41690A5508Q001		
5800	18 × 39	B41690A5588Q001		B41790A5588Q001
8000	21 × 39	B41690A5808Q001		B41790A5808Q001
10000	21 × 49	B41690A5109Q001		B41790A5109Q001
<b><math>V_R = 35 \text{ V DC}</math></b>				
1000	14 × 25	B41690A7108Q001	B41690A7108Q003	B41790A7108Q001
1400	16 × 25	B41690A7148Q001	B41690A7148Q003	B41790A7148Q001
1900	16 × 30	B41690A7198Q001	B41690A7198Q003	B41790A7198Q001
2300	16 × 35	B41690B7238Q001	B41690B7238Q003	B41790B7238Q001
2500	18 × 30	B41690A7258Q001		B41790A7258Q001
3000	20 × 29	B41690A7308Q001		
3800	18 × 39	B41690A7388Q001		B41790A7388Q001
5200	21 × 39	B41690A7528Q001		B41790A7528Q001
7000	21 × 49	B41690A7708Q001		B41790A7708Q001
<b><math>V_R = 40 \text{ V DC}</math></b>				
600	12 × 30	B41690A7607Q001	B41690A7607Q003	B41790A7607Q001
1000	14 × 30	B41690B7108Q001	B41690B7108Q003	B41790B7108Q001
1400	16 × 30	B41690B7148Q001	B41690B7148Q003	B41790B7148Q001
1800	18 × 30	B41690A7188Q001		B41790A7188Q001
2300	20 × 29	B41690A7238Q001		
2700	18 × 39	B41690A7278Q001		B41790A7278Q001
3900	21 × 39	B41690A7398Q001		B41790A7398Q001
5200	21 × 49	B41690B7528Q001		B41790B7528Q001

**B41690, B41790**
**Ultra compact – up to 140 °C**
**Technical data**

$C_R$ 100 Hz 20 °C $\mu\text{F}$	Case dimensions $d \times l$ mm	$\text{ESR}_{\text{max}}$ 100 Hz 20 °C m $\Omega$	$\text{ESR}_{\text{max}}$ 100 Hz –40 °C m $\Omega$	$\text{ESR}_{\text{max}}$ 10 kHz 20 °C m $\Omega$	$Z_{\text{max}}$ 100 kHz 20 °C m $\Omega$	$I_{\text{AC,max}}$ 10 kHz 105 °C A	$I_{\text{AC,max}}$ 10 kHz 125 °C A	$I_{\text{AC,R}}$ 10 kHz 125 °C A	$I_{\text{AC,max}}$ 10 kHz 140 °C A
<b><math>V_R = 25 \text{ V DC}</math></b>									
1200	12 × 30	135	1000	70	68	4.9	3.6	2.5	1.6
2000	14 × 30	90	620	48	47	5.8	4.3	3.0	1.9
2900	16 × 30	60	460	32	31	8.4	6.2	4.3	2.8
3000	18 × 25	58	530	40	38	7.5	5.6	3.8	2.5
3900	18 × 30	45	330	25	24	9.4	7.0	4.8	3.1
4300	16 × 39	40	310	21	21	11.6	8.6	5.9	3.5
5000	20 × 29	37	260	21	21	10.0	7.4	5.1	3.3
5800	18 × 39	30	230	17	17	12.9	9.5	6.6	4.3
8000	21 × 39	25	160	14	14	14.2	10.5	7.3	4.8
10000	21 × 49	20	130	11	11	17.7	13.2	9.1	5.9
<b><math>V_R = 35 \text{ V DC}</math></b>									
1000	14 × 25	125	900	65	63	4.7	3.5	2.4	1.5
1400	16 × 25	100	620	52	50	5.0	3.7	2.6	1.7
1900	16 × 30	65	460	32	31	8.2	6.1	4.2	2.7
2300	16 × 35	54	440	33	31	9.7	7.2	5.0	3.2
2500	18 × 30	50	360	25	24	9.4	7.0	4.8	3.1
3000	20 × 29	45	310	23	22	10.0	7.4	5.1	3.3
3800	18 × 39	35	210	17	17	12.7	9.4	6.5	4.2
5200	21 × 39	27	160	14	14	14.0	10.4	7.2	4.7
7000	21 × 49	21	120	11	11	17.7	13.2	9.1	5.9
<b><math>V_R = 40 \text{ V DC}</math></b>									
600	12 × 30	165	1000	70	68	4.9	3.6	2.5	1.6
1000	14 × 30	105	620	48	47	5.8	4.3	3.0	1.9
1400	16 × 30	70	460	32	31	8.2	6.1	4.2	2.7
1800	18 × 30	58	330	26	25	9.4	6.9	4.8	3.1
2300	20 × 29	48	260	23	22	10.0	7.4	5.1	3.3
2700	18 × 39	40	210	17	17	12.7	9.4	6.5	4.2
3900	21 × 39	30	150	14	14	14.0	10.4	7.2	4.7
5200	21 × 49	23	120	11	11	17.7	13.2	9.1	5.9

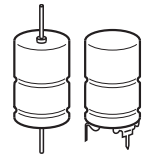



**Useful life<sup>1)</sup>**

depending on ambient temperature  $T_A$  under ripple current operating conditions at  $V_R$

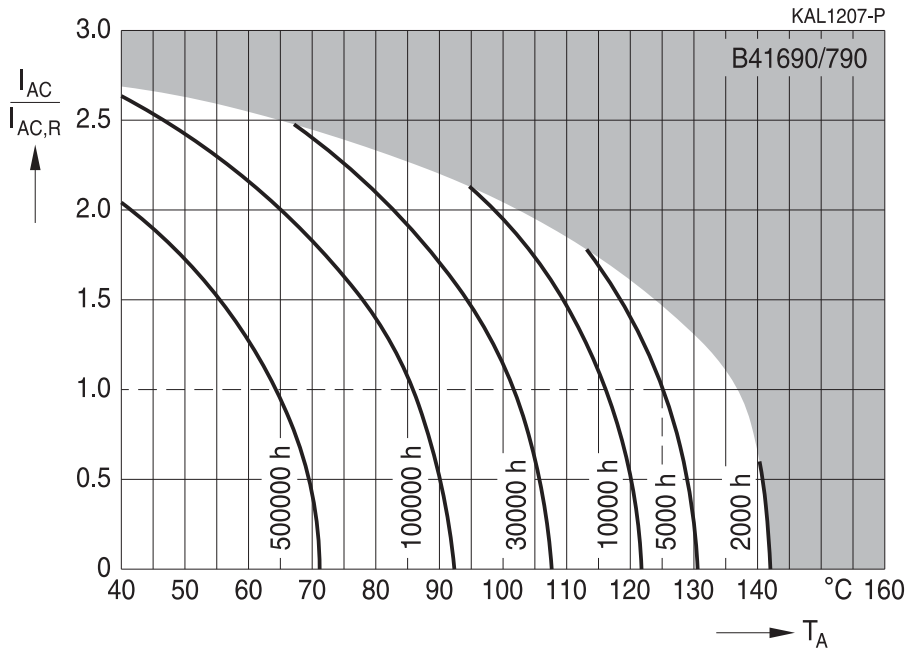

**Useful life<sup>1)</sup>**

depending on case temperature  $T_C$  under ripple current operating conditions at  $V_R$

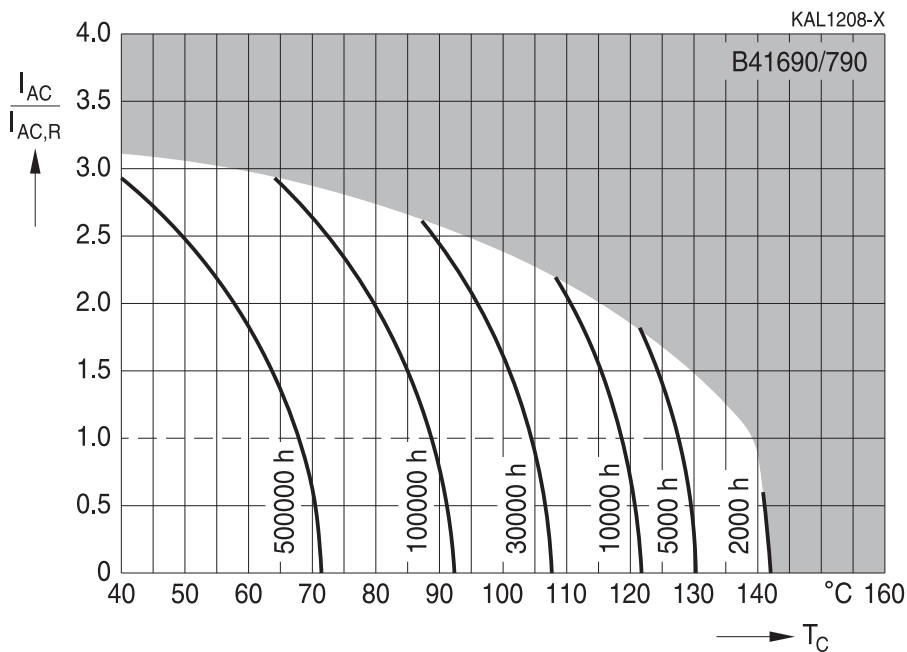

1) Refer to chapter "General technical information, 5 Useful life" on how to interpret useful life.

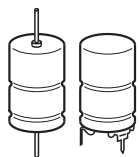

**B41690, B41790**

**Ultra compact – up to 140 °C**

**Useful life<sup>1)</sup>**

depending on ambient temperature  $T_A$  under ripple current operating conditions at  $V_{op}$

$V_R = 25\text{ V}: V_{op} \leq 20\text{ V}; V_R = 35\text{ V}: V_{op} \leq 30\text{ V};$

$V_R = 40\text{ V}: V_{op} \leq 35\text{ V}$

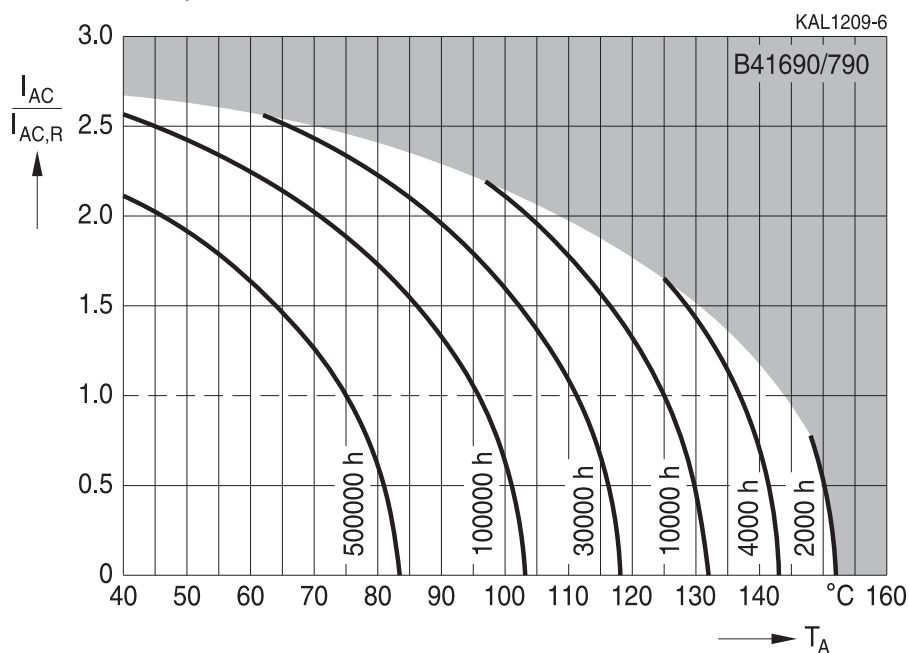

**Useful life<sup>1)</sup>**

depending on case temperature  $T_C$  under ripple current operating conditions at  $V_{op}$

$V_R = 25\text{ V}: V_{op} \leq 20\text{ V}; V_R = 35\text{ V}: V_{op} \leq 30\text{ V};$

$V_R = 40\text{ V}: V_{op} \leq 35\text{ V}$

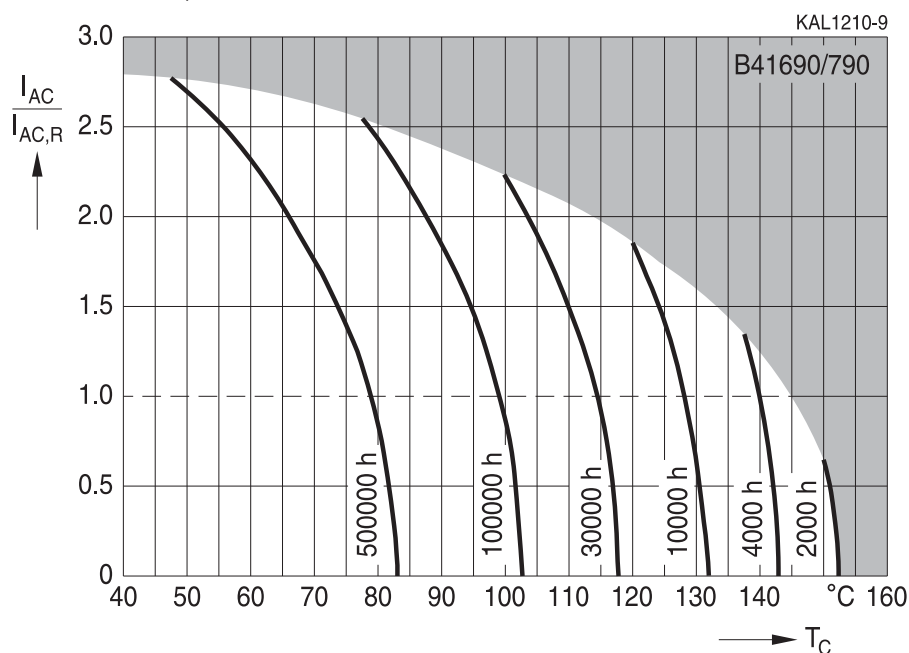

1) Refer to chapter "General technical information, 5 Useful life" on how to interpret useful life.

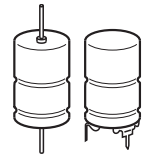

**Frequency factor of permissible ripple current  $I_{AC}$  versus frequency  $f$**

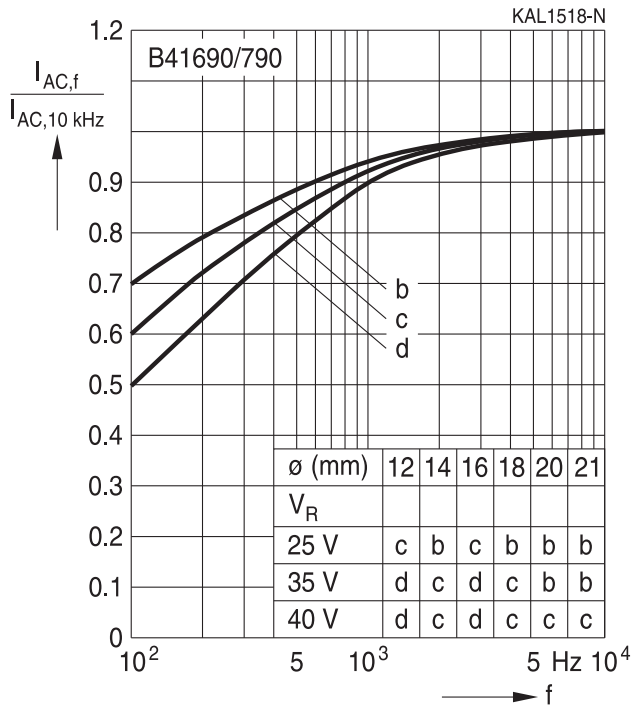

**Frequency characteristics of ESR**  
Typical behavior

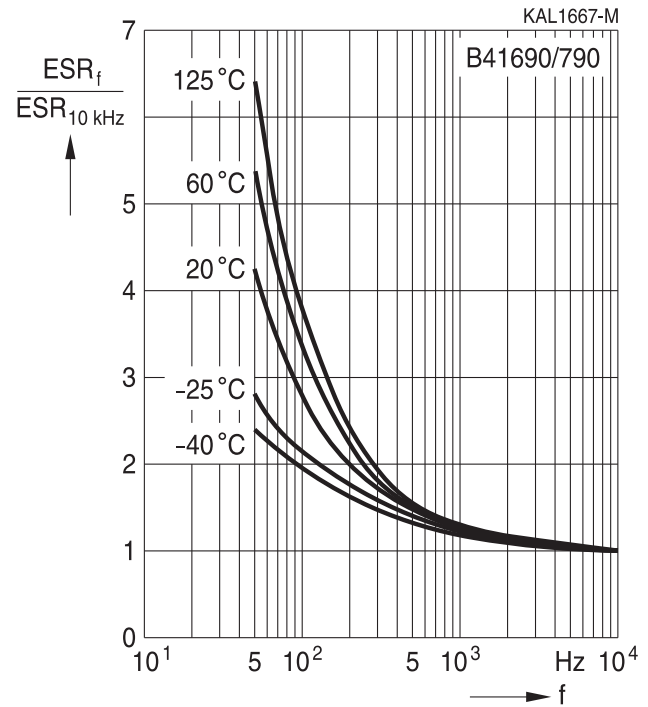

**Equivalent series resistance ESR versus frequency  $f$**

Typical behavior for 1000  $\mu$ F/40 V

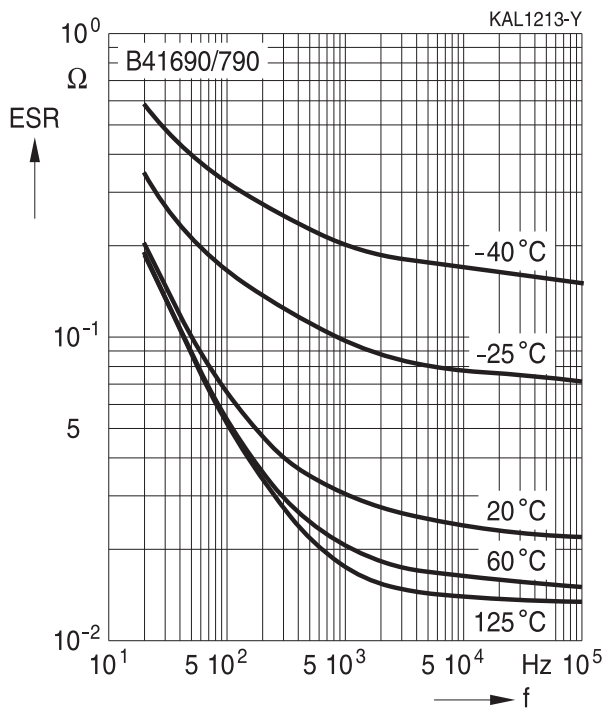

**Impedance  $Z$  versus frequency  $f$**

Typical behavior for 1000  $\mu$ F/40 V

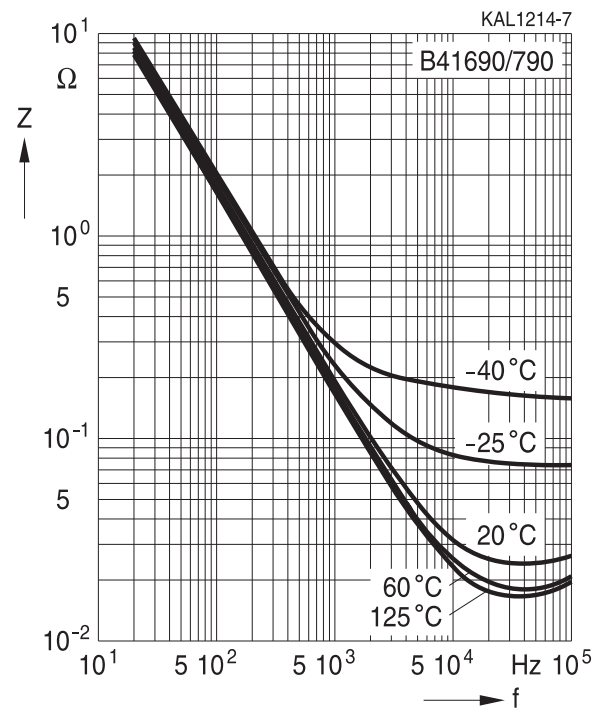

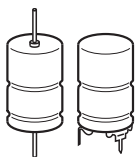

**B41690, B41790**

**Ultra compact – up to 140 °C**

## Cautions and warnings

### Personal safety

The electrolytes used by EPCOS have been optimized both with a view to the intended application and with regard to health and environmental compatibility. They do not contain any solvents that are detrimental to health, e.g. dimethyl formamide (DMF) or dimethyl acetamide (DMAC).

Furthermore, some of the high-voltage electrolytes used by EPCOS are self-extinguishing.

As far as possible, EPCOS does not use any dangerous chemicals or compounds to produce operating electrolytes, although in exceptional cases, such materials must be used in order to achieve specific physical and electrical properties because no alternative materials are currently known. We do, however, restrict the amount of dangerous materials used in our products to an absolute minimum.

Materials and chemicals used in EPCOS aluminum electrolytic capacitors are continuously adapted in compliance with the EPCOS Corporate Environmental Policy and the latest EU regulations and guidelines such as RoHS, REACH/SVHC, GADSL, and ELV.

MDS (Material Data Sheets) are available on the EPCOS website for all types listed in the data book. MDS for customer specific capacitors are available upon request.

MSDS (Material Safety Data Sheets) are available for all of our electrolytes upon request.

Nevertheless, the following rules should be observed when handling aluminum electrolytic capacitors: No electrolyte should come into contact with eyes or skin. If electrolyte does come into contact with the skin, wash the affected areas immediately with running water. If the eyes are affected, rinse them for 10 minutes with plenty of water. If symptoms persist, seek medical treatment. Avoid inhaling electrolyte vapor or mists. Workplaces and other affected areas should be well ventilated. Clothing that has been contaminated by electrolyte must be changed and rinsed in water.

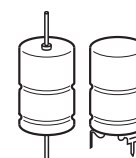

## Product safety

The table below summarizes the safety instructions that must be observed without fail. A detailed description can be found in the relevant sections of chapter "General technical information".

Topic	Safety information	Reference chapter "General technical information"
Polarity	Make sure that polar capacitors are connected with the right polarity.	1 "Basic construction of aluminum electrolytic capacitors"
Reverse voltage	Voltages of opposite polarity should be prevented by connecting a diode.	3.1.6 "Reverse voltage"
Mounting position of screw-terminal capacitors	Screw terminal capacitors must not be mounted with terminals facing down unless otherwise specified.	11.1. "Mounting positions of capacitors with screw terminals"
Robustness of terminals	The following maximum tightening torques must not be exceeded when connecting screw terminals: M5: 2.5 Nm M6: 4.0 Nm	11.3 "Mounting torques"
Mounting of single-ended capacitors	The internal structure of single-ended capacitors might be damaged if excessive force is applied to the lead wires. Avoid any compressive, tensile or flexural stress. Do not move the capacitor after soldering to PC board. Do not pick up the PC board by the soldered capacitor. Do not insert the capacitor on the PC board with a hole space different to the lead space specified.	11.4 "Mounting considerations for single-ended capacitors"
Soldering	Do not exceed the specified time or temperature limits during soldering.	11.5 "Soldering"
Soldering, cleaning agents	Do not allow halogenated hydrocarbons to come into contact with aluminum electrolytic capacitors.	11.6 "Cleaning agents"
Upper category temperature	Do not exceed the upper category temperature.	7.2 "Maximum permissible operating temperature"
Passive flammability	Avoid external energy, e.g. fire.	8.1 "Passive flammability"

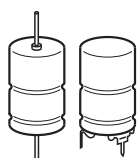

**B41690, B41790**

**Ultra compact – up to 140 °C**

Topic	Safety information	Reference chapter "General technical information"
Active flammability	Avoid overload of the capacitors.	8.2 "Active flammability"
Maintenance	Make periodic inspections of the capacitors. Before the inspection, make sure that the power supply is turned off and carefully discharge the capacitors. Do not apply excessive mechanical stress to the capacitor terminals when mounting.	10 "Maintenance"
Storage	Do not store capacitors at high temperatures or high humidity. Capacitors should be stored at +5 to +35 °C and a relative humidity of ≤ 75%.	7.3 "Shelf life and storage conditions"
		Reference chapter "Capacitors with screw terminals"
Breakdown strength of insulating sleeves	Do not damage the insulating sleeve, especially when ring clips are used for mounting.	"Screw terminals – accessories"

### Display of ordering codes for EPCOS products

The ordering code for one and the same product can be represented differently in data sheets, data books, other publications and the website of EPCOS, or in order-related documents such as shipping notes, order confirmations and product labels. The varying representations of the ordering codes are due to different processes employed and do not affect the specifications of the respective products.

Detailed information can be found on the Internet under [www.epcos.com/orderingcodes](http://www.epcos.com/orderingcodes).

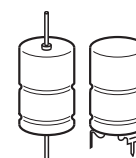
**Symbols and terms**

Symbol	English	German
C	Capacitance	Kapazität
$C_R$	Rated capacitance	Nennkapazität
$C_S$	Series capacitance	Serienkapazität
$C_{S,T}$	Series capacitance at temperature T	Serienkapazität bei Temperatur T
$C_f$	Capacitance at frequency f	Kapazität bei Frequenz f
d	Case diameter, nominal dimension	Gehäusedurchmesser, Nennmaß
$d_{max}$	Maximum case diameter	Maximaler Gehäusedurchmesser
ESL	Self-inductance	Eigeninduktivität
ESR	Equivalent series resistance	Ersatzserienwiderstand
$ESR_f$	Equivalent series resistance at frequency f	Ersatzserienwiderstand bei Frequenz f
$ESR_T$	Equivalent series resistance at temperature T	Ersatzserienwiderstand bei Temperatur T
f	Frequency	Frequenz
I	Current	Strom
$I_{AC}$	Alternating current (ripple current)	Wechselstrom
$I_{AC,RMS}$	Root-mean-square value of alternating current	Wechselstrom, Effektivwert
$I_{AC,f}$	Ripple current at frequency f	Wechselstrom bei Frequenz f
$I_{AC,max}$	Maximum permissible ripple current	Maximal zulässiger Wechselstrom
$I_{AC,R}$	Rated ripple current	Nennwechselstrom
$I_{leak}$	Leakage current	Reststrom
$I_{leak,op}$	Operating leakage current	Betriebsreststrom
l	Case length, nominal dimension	Gehäuselänge, Nennmaß
$l_{max}$	Maximum case length (without terminals and mounting stud)	Maximale Gehäuselänge (ohne Anschlüsse und Gewindebolzen)
R	Resistance	Widerstand
$R_{ins}$	Insulation resistance	Isolationswiderstand
$R_{symm}$	Balancing resistance	Symmetrierwiderstand
T	Temperature	Temperatur
$\Delta T$	Temperature difference	Temperaturdifferenz
$T_A$	Ambient temperature	Umgebungstemperatur
$T_C$	Case temperature	Gehäusetemperatur
$T_B$	Capacitor base temperature	Temperatur des Gehäusebodens
t	Time	Zeit
$\Delta t$	Period	Zeitraum
$t_b$	Service life (operating hours)	Brauchbarkeitsdauer (Betriebszeit)

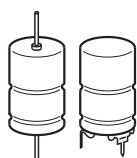

B41690, B41790

Ultra compact – up to 140 °C

Symbol	English	German
V	Voltage	Spannung
$V_F$	Forming voltage	Formierspannung
$V_{op}$	Operating voltage	Betriebsspannung
$V_R$	Rated voltage, DC voltage	Nennspannung, Gleichspannung
$V_S$	Surge voltage	Spitzenspannung
$X_C$	Capacitive reactance	Kapazitiver Blindwiderstand
$X_L$	Inductive reactance	Induktiver Blindwiderstand
Z	Impedance	Scheinwiderstand
$Z_T$	Impedance at temperature T	Scheinwiderstand bei Temperatur T
$\tan \delta$	Dissipation factor	Verlustfaktor
$\lambda$	Failure rate	Ausfallrate
$\epsilon_0$	Absolute permittivity	Elektrische Feldkonstante
$\epsilon_r$	Relative permittivity	Dielektrizitätszahl
$\omega$	Angular velocity; $2 \cdot \pi \cdot f$	Kreisfrequenz; $2 \cdot \pi \cdot f$

### Note

All dimensions are given in mm.



## Important notes

The following applies to all products named in this publication:

1. Some parts of this publication contain **statements about the suitability of our products for certain areas of application**. These statements are based on our knowledge of typical requirements that are often placed on our products in the areas of application concerned. We nevertheless expressly point out **that such statements cannot be regarded as binding statements about the suitability of our products for a particular customer application**. As a rule, EPCOS is either unfamiliar with individual customer applications or less familiar with them than the customers themselves. For these reasons, it is always ultimately incumbent on the customer to check and decide whether an EPCOS product with the properties described in the product specification is suitable for use in a particular customer application.
2. We also point out that **in individual cases, a malfunction of electronic components or failure before the end of their usual service life cannot be completely ruled out in the current state of the art, even if they are operated as specified**. In customer applications requiring a very high level of operational safety and especially in customer applications in which the malfunction or failure of an electronic component could endanger human life or health (e.g. in accident prevention or lifesaving systems), it must therefore be ensured by means of suitable design of the customer application or other action taken by the customer (e.g. installation of protective circuitry or redundancy) that no injury or damage is sustained by third parties in the event of malfunction or failure of an electronic component.
3. **The warnings, cautions and product-specific notes must be observed.**
4. In order to satisfy certain technical requirements, **some of the products described in this publication may contain substances subject to restrictions in certain jurisdictions (e.g. because they are classed as hazardous)**. Useful information on this will be found in our Material Data Sheets on the Internet ([www.epcos.com/material](http://www.epcos.com/material)). Should you have any more detailed questions, please contact our sales offices.
5. We constantly strive to improve our products. Consequently, **the products described in this publication may change from time to time**. The same is true of the corresponding product specifications. Please check therefore to what extent product descriptions and specifications contained in this publication are still applicable before or when you place an order. We also **reserve the right to discontinue production and delivery of products**. Consequently, we cannot guarantee that all products named in this publication will always be available. The aforementioned does not apply in the case of individual agreements deviating from the foregoing for customer-specific products.
6. Unless otherwise agreed in individual contracts, **all orders are subject to the current version of the "General Terms of Delivery for Products and Services in the Electrical Industry" published by the German Electrical and Electronics Industry Association (ZVEI)**.

## Important notes

7. The trade names EPCOS, CeraDiode, CeraLink, CeraPad, CeraPlas, CSMP, CSSP, CTVS, DeltaCap, DigiSiMic, DSSP, ExoCore, FilterCap, FormFit, LeaXield, MiniBlue, MiniCell, MKD, MKK, MotorCap, PCC, PhaseCap, PhaseCube, PhaseMod, PhiCap, PQSine, SIFERRIT, SIFI, SIKOREL, SilverCap, SIMDAD, SiMic, SIMID, SineFormer, SIOV, SIP5D, SIP5K, TFAP, ThermoFuse, WindCap are **trademarks registered or pending** in Europe and in other countries. Further information will be found on the Internet at [www.epcos.com/trademarks](http://www.epcos.com/trademarks).